

# Sooner or later, your friends are going to trust you with something very important to them.

- Experience the feeling of being in control behind the wheel.
- Drive the latest cars.
- Friendly professional instructors.
- Learn advanced collision avoidance techniques — they could save a friend's life.
- Insurance discounts normally save cost of training.
- Over 300,000 graduates since 1938.
- Also offering defensive driving courses for demerit reduction.

## Their lives.



Alberta Motor Association  
in Lethbridge  
Call 328-1186

**DRIVER EDUCATION**

ANOTHER WAY TO USE AMA 

**ACCLAIM**  
DRIVER EDUCATION LTD.



**Finest Professional DRIVER EDUCATION**

- ★ GOVERNMENT APPROVED COURSES
- ★ INSURANCE DISCOUNT
- ★ DEFENSIVE DRIVING COURSES (DEMERIT POINT REDUCTION)
- ★ INCOME TAX DEDUCTIBLE
- ★ COMPREHENSIVE COURSES & BRUSH-UP LESSONS
- ★ FREE PICK-UP WITHIN CITY LIMIT
- ★ AUTOMATIC OR STANDARD TRANSMISSION
- ★ ROAD TESTS APPOINTMENT ARRANGED

**320-6177**  
2, 321A - 6th ST., LETHBRIDGE  
A GOOD DRIVER EDUCATION LASTS FOR A LIFETIME (GIFT CERTIFICATES AVAILABLE)

**Driving Instruction**

Acclaim Driver Education Ltd  
2321a 6 St S .....Lethbridge 320-6177  
(See Our Display Advertisement)

Alberta Motor Association  
608 5 Av S .....Lethbridge 328-1186  
(See Our Display Advertisement)

Class 1 Driving School Ltd  
3215a 16 Av N .....Lethbridge 327-3144  
(See Our Display Advertisement)

L A Driving School  
2215 39 St N .....Lethbridge 328-8025  
(See Our Display Advertisement)

**S K DRIVER TRAINING**  
PROFESSIONAL DRIVER TRAINING SERVICE  
CALL 32(TRUCK)  
605 36 St N .....Lethbridge 328-7825

**Drug Abuse Information & Treatment Centres**

St Paul Treatment Centre  
Box 179 Cardston .....Standoff 737-3757  
Fax Line .....Standoff 737-2811

**Dry Goods-Wholesale**

Western Varieties & Dry Goods (1977) Ltd  
10187 103 St .....Edmonton 424-0481

**Dryers-Clothes**

Canadian Western Natural Gas  
410 Stafford Dr N .....Lethbridge 327-4551

Fairfield Appliance Services Ltd  
1244 3 Av S .....Lethbridge 327-6684

Let Your Fingers Do The Walking A Short Cut For Your Customers.

**CLASS 1 DRIVING SCHOOL LTD.**  
— TRAINING TOMORROW'S PROFESSIONAL DRIVER —

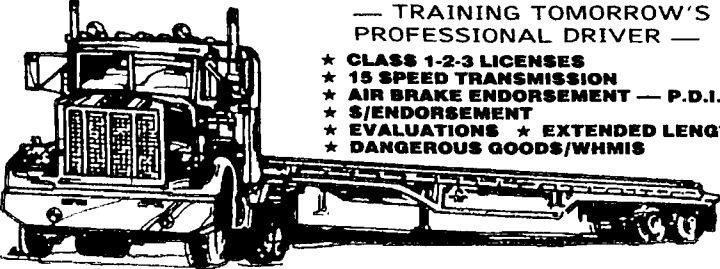

- ★ CLASS 1-2-3 LICENSES
- ★ 15 SPEED TRANSMISSION
- ★ AIR BRAKE ENDORSEMENT — P.D.I.C.
- ★ S/ENDORSEMENT
- ★ EVALUATIONS ★ EXTENDED LENGTH
- ★ DANGEROUS GOODS/WHMIS

**327-3144**  
3215A - 16th Avenue N., Lethbridge

- OPEN 7 DAYS A WEEK
- INCOME TAX DEDUCTIBLE
- G.S.T. EXEMPT
- FINANCIAL ASSISTANCE AVAILABLE

**L.A. Driving School**  
"TRUCK DRIVER TRAINING & EDUCATION"

GOVT APPROVED AIR BRAKES COURSE  
PROFESSIONAL DRIVERS IMPROVEMENT COURSE P.D.I.C.  
COMPLETE COURSE OR HOURLY INSTRUCTION

FOR CLASS 1 & 3 LICENCE  
EVENING & WEEKEND TRAINING  
LICENCED & BONDED  
FINANCIAL ASSISTANCE AVAILABLE  
TRUCK RENTALS FOR ROAD TESTS



**328-8025**  
2215 - 39th ST. N., LETH.

INCOME TAX DEDUCTIBLE

**Duplicating Machines & Supplies**

Minolta Office Systems  
1802 2 Av S.....Lethbridge 328-1188

**Duplicating Services**

Copy Express 811 3 Av S.....Lethbridge 329-9055  
Fax Line.....Lethbridge 328-9055  
(See Our Display Advertisement)

S & G Printers  
406 Stafford Dr S.....Lethbridge 320-7655



**PHOTOCOPIES**  
**copy express**  
**COPIES IN FULL COLOR**  
We Specialize In Copying

- 2 Sided Copies
- Oversize Copies
- Stapling • Folding
- Cerlox Binding With Cover Printing
- Variable Reductions
- Enlargements
- Laminating
- Facsimile Transmission
- Newsletters
- Reports
- Flyers
- Architectural Specifications
- Training Manuals
- Mailing Labels
- Transparencies
- Resumes

**OPEN SATURDAYS**

329-9055  
500 BROADWAY, LETHBRIDGE

**Dust Collecting Systems**

Carter Day Industries (Canada) Ltd  
15 6130 4 St SE.....Calgary 253-6309

**Duty Free Shops**

Altan Duty Free Shops Ltd  
Box 218 Coutts Crossing.....Coutts 344-3000  
(See Our Display Advertisement)



**ALTAN DUTY FREE SHOPS LTD.**  
GIFT ITEMS & SOUVENIRS

- ★ Liquor
- ★ Pottery
- ★ Perfumes
- ★ Post Cards
- ★ Games
- ★ Cigarettes
- ★ Figurines
- ★ Novelties
- ★ T-Shirts
- ★ Toys

★ Smokers Supplies & Sundries  
HOURS: 7:00 A.M. - 11:00 P.M.  
7 DAYS A WEEK

**344-3000**  
BOX 218, COUTTS CROSSING, COUTTS

**The best GAS SAVER in town!**

Drive your phone instead of your car. Save a trip.



**Dyers**

**MONEYSWORTH & BEST QUALITY SHOE REPAIR**  
The Lethbridge Centre.....Lethbridge 320-8441

**Ear Piercing Service**

Barb's Hair Styles.....Milk River 647-2447  
**FACE FACTS**  
5097 St S.....Lethbridge 320-9493  
**MERLE NORMAN BOUTIQUE DOWNTOWN**  
330 6 St S.....Lethbridge 320-7780

**Eavestrouging**

**A-1 SUPER SEAMLESS EXTERIORS**  
.....Lethbridge 329-4211  
(See Our Display Advertisement)  
**Cowan Furnace Cleaning Service**  
Box 1815.....Clareholm 625-2565  
(See Our Display Advertisement)

**EASY EAVES**  
CONTINUOUS EAVESTROUGHING  
5" PREFINISHED GUTTER  
Box 2443.....Pincher Creek 627-3698

(CONTINUED NEXT LISTING PAGE)

Telephone service is a friendly service. The people who operate and maintain it take a genuine satisfaction in serving you pleasantly and well. People who use the telephone a great deal find that friendliness is an instinctive habit. The telephone helps folks to know each other better.

**COWAN FURNACE CLEANING SERVICE**

# Junior's

## Continuous Eavestrouging Ltd.

- EAVESTROUGHING
- FASCIA
- SOFFIT
- CUSTOM MADE FLASHING TO YOUR DESIGN

**"SERVING SOUTHERN ALBERTA"**

**382-9913 OR 223-4762**  
(LETHBRIDGE CELLULAR) (TABER OFFICE)

## THE GUTTER SHOP

a Division of FINE-LINE WINDOWS & SIDING LTD.

- SIDING
- SOFFIT
- FASCIA
- WINDOWS
- FREE ESTIMATES

**329-0740**  
249 - 12th ST. N.  
LETHBRIDGE

"Serving Lethbridge for more than 20 years"

## A-1 SUPER SEAMLESS EXTERIORS

The Finest, Continuous Eavestrouging,  
**29GA Steel**  
Wood Grain Available  
Matching Fascia & Capping

**329-4211**  
**LETHBRIDGE**  
**223-1414**  
**TABER**  
FREE ESTIMATES

## GLENN'S

CONTINUOUS EAVESTROUGHING

- VINYL, METAL & WOOD SIDING
- SOFFITS & FASCIA
- METAL & ALUMINUM ROOFS
- WINDOW & DOOR CAPPINGS

BOX 2185, CLARESHOLM

**625-3893**

## COWAN FURNACE CLEANING SERVICE

**CONTINUOUS 5" PREFINISHED EAVESTROUGH**

- SIDING
- SOFFIT
- FASCIA

**625-2565**  
BOX 1815  
CLARESHOLM

## PEERLESS BUILDING PRODUCTS

360326 ALBERTA Ltd.

- CONTINUOUS COLORED
- 5 INCH RESIDENTIAL TROUGH
- 6 INCH COMMERCIAL TROUGH
- BAKED ON ENAMEL FINISH

WE ALSO HANDLE ALL TYPES OF SIDING  
FREE ESTIMATES

**328-6600**  
1228B - 31st ST. N., LETHBRIDGE  
FAX 328-6797  
MEDICINE HAT 627-5700  
MEDICINE HAT MOBILE XJ4-5700

# SAWILLA RENOVATIONS LTD.

## 5" CONTINUOUS STEEL EAVESTROUGHING

■ SIDING

■ STUCCO

■ SOFFIT & FASCIA

■ CUSTOM EAVESTROUGH COLORS

SERVING LETHBRIDGE & AREA FOR OVER 20 YEARS

LICENSED, BONDED & INSURED FOR YOUR PEACE OF MIND  
FREE ESTIMATES  
OPEN SATURDAYS

### 327-4496

FAX: 320-1124  
SHOWROOM LOCATION  
432 - 13th ST. N., LETHBRIDGE

### Eavestrouging (Cont'd)

Glenns Continuous Eavestrouging  
Box 2185 W ..... Claresholm 625-3893  
(See Our Display Advertisement)

Gutter Shop The  
249 12 St N ..... Lethbridge 329-0740  
(See Our Display Advertisement)

Junior's Continuous Eavestrouging Ltd  
..... Taber 223-4762  
(See Our Display Advertisement)

LOUIS' EXTERIORS & EAVESTROUGHING  
1922 4 Av N ..... Lethbridge 320-2726

Peerless Building Products  
1228b 31 St N ..... Lethbridge 328-6600  
(See Our Display Advertisement)

Sawilla Renovations Ltd  
432 13 St N ..... Lethbridge 327-4496  
(See Our Display Advertisement)

STAR-BRITE EAVESTROUGHING & SIDING LTD  
1280 2 Av S ..... Lethbridge 328-7501  
(See Our Display Advertisement)

True Line Eavestrouging Ltd  
Box 637 ..... Taber 223-2994  
(See Our Display Advertisement)

### 4 GOOD REASONS FOR HANDLING COMPLAINTS BY LONG DISTANCE

You can talk over matters at once. Promptness often prevents loss of a customer.  
You can build closer relations with customers.  
You can use tact in delicate situations. And because people talk more freely than they write, you can frequently trace the real reason for the complaint and prevent similar complaints in the future.

### Educational Scholarship Plans

Canadian Scholarship Trust Plan  
(No Charge Dial) ..... 1-800-387-4622

Canadian Scholarship Trust Plan  
Beverly Fraser  
2627 22 Av S ..... Lethbridge 328-0627

CHILDREN'S EDUCATION TRUST  
THE MOST FLEXIBLE & INNOVATIVE  
NON-PROFIT R.E.S.P.  
CALL FOR MORE INFORMATION  
..... Lethbridge 327-0011

### Eggs-Retail

Coaldale Egg Farms (1979) Ltd  
2407 18 St ..... Coaldale 345-4612

### Eggs-Wholesale

COALDALE EGG FARMS (1979) LTD  
2407 18 St ..... Coaldale 345-4612  
Fax Line ..... Coaldale 345-2991

SOUTHALTA PRODUCE  
2215 39 St N ..... Lethbridge 327-2388

### Electric Equipment-Service & Repairing

Westinghouse Canada Inc  
Services Division  
2934 12 Av N ..... Lethbridge 327-6446

### Electric Equipment & Supplies-Retail

DUFF SOUND EQUIPMENT LTD  
NUTONE  
AUTHORIZED SERVICE CENTRE  
1108 6 Av S ..... Lethbridge 327-1815

THUNDERBIRD HOME CENTRES  
920 2a Av N ..... Lethbridge 329-3188  
(See Our Display Advertisement)



### THUNDERBIRD HOME CENTRES

- KITCHENS
- BATHS
- ELECTRICAL
- PLUMBING
- LIGHTING
- CERAMIC TILE

Bring In Your Plans Or Ideas  
For Free Estimates

### 329-3188

920 - 2A Ave. North, LETHBRIDGE

### Electric Equipment & Supplies-Whlse

ALLIED WIRE & CABLE LTD  
4503 1 St SE Calgary (No Charge Dial) ..... 1-800-665-5267

BARTLE & GIBSON CO LTD  
COMMERCIAL & RESIDENTIAL  
ELECTRICAL SUPPLIES  
969 17 St SW ..... Medicine Hat 527-3565

Brews R L & Son Ltd  
(No Charge Dial) Calgary ..... 1-800-661-6884  
(See Our Display Advertisement)

EECOL ELECTRIC LTD  
Garth Balfour Res. 320-5111  
Doug Wenzel Res. 381-1267  
Calgary Ofc. 65 Highfield Pl SE 243-5594  
2931 12 Av N ..... Lethbridge 328-2353

Newcomer to town?

Use the YELLOW PAGES to locate  
new dealers to serve you.

### Electric Equipment & Supplies (Cont'd)

FALVO ELECTRICAL SUPPLY LTD  
Dealers New & Reconditioned Electrical  
Materials, Circuit Breakers, Motor Controls  
We Buy & Sell  
Edm (No Charge Dial) ..... 1-800-661-8892

GESCAN LTD  
24 HOUR EMERGENCY SERVICE  
B1 3106 9 Av N ..... Lethbridge 327-4184  
If Busy Call ..... 320-7656  
Dale Kunger Res ..... 381-4228

Gough Electric Division Of Guillevin  
International Inc  
3106 9 Av N ..... Lethbridge 320-2522  
Fax Line ..... Lethbridge 320-2017

Independent Electrical Wholesale  
2417 10 Av N ..... Lethbridge 328-9330

NATIONAL ELECTRICAL SUPPLY LTD  
3738 97 St Edmonton (No Charge Dial) ..... 1-800-661-6972

Ross Electronics Ltd  
3006 2 Av N ..... Lethbridge 327-1933  
Fax Line ..... Lethbridge 328-8313

Texcan Cables Limited  
Bay 2 2315 30 Av NE Calgary (No Charge Dial) ..... 1-800-382-8590  
(See Our Display Advertisement)

WESCO-Distribution  
2934 12 Av N ..... Lethbridge 320-2255

WESTWAY ELECTRICAL SUPPLIES & SERVICES LTD  
We Purchase EXCESS Inventories of  
New & Restocked Electrical Materials  
Edm (No Charge Dial) ..... 1-800-661-9642

Why not check into the sales  
building possibilities of the  
YELLOW PAGES? Call the bus-  
iness office for information on  
YELLOW PAGE advertising.



### BREWS THE COMPLETE INDUSTRIAL ELECTRIC RESOURCE CENTRE

- ELECTRIC HEATING
- MOTOR CONTROL
- FUSES

HAZARDOUS LOCATION EQUIP.  
RELAYS

(NO CHARGE DIAL) CALGARY  
**1-800-661-6884**  
R.L. BREWS & SON LTD.

### TRUE LINE EAVESTROUGHING LTD.

- 5" CONTINUOUS PREFINISHED EAVESTROUGHING
- SIDING
- SOFFIT
- FASCIA
- ADDITIONS
- RENOVATIONS

FREE ESTIMATES **223-2994**

BOX 637 TABER, ALTA. COALDALE RES: 345-2041  
CELLULAR: 382-1402

### Economic Research & Analysis

Elton & Assoc Box 659 ..... Raymond 752-3668  
H B T Agra Limited  
1430b 31 St N ..... Lethbridge 327-7474  
McKenzie-Quo International Ltd  
314 McMaster Blvd W ..... Lethbridge 320-8684  
U M A Engineering Ltd  
514 Stafford Dr N ..... Lethbridge 329-4822

### Educational Consultants

C D S Ltd Box 2073 ..... Lethbridge 328-3663  
Edu-Cater Skills Centre  
Upstrs 505 7 St S ..... Lethbridge 381-7768  
PLATO EDUCATION SERVICES -  
See Tro Learning (Canada) Inc  
Primerica Financial Services  
1415 33 St N ..... Lethbridge 380-3903  
Fax Line ..... Lethbridge 320-6406  
Tro Learning (Canada) Inc  
1840 10123 99 St ..... Edmonton 424-4717

### Star-Brite

Eavestrouging & Siding Ltd.



- CONTINUOUS 4" & 5" PREFINISHED EAVESTROUGHES
- GUTTERS & DOWNSPOUTS

SERVING LETHBRIDGE & AREA

### 328-7501

1280 - 2nd AVENUE S.  
BOX 384, LETHBRIDGE T1J 3Y7  
Authorized Dealer Hunter Douglas

### TEXCAN CABLES LIMITED

SERVING YOU IN THE  
ELECTRICAL  
WIRE & CABLE INDUSTRY

- Belden Rep.
- Instrumentation
- IBM Cabling Systems  
Authorized Distributor
- Low Temp. Control Cables
- Hi Temperature
- Ethernet Products
- "D" Subminiature Products
- Connectors, Cables & Acc.

"WHEN OTHERS CAN'T, TEXCAN"  
BAY 2, 2315 - 30th AVENUE N.E.  
CALGARY

### 1-800-382-8590

**Motor Controls**

**ALLEN BRADLEY MOTOR CONTROLS—**  
DISTRIBUTORS  
WESTBURNE ELECTRIC SUPPLY (ALBERTA)  
3115 16 Av N -----Lethbridge 327-8561

Hagen Electric Ltd  
1202 2 Av S -----Lethbridge 328-8826

**INDUSTRIAL SUPPLY DISCOUNT**  
CENTRE  
Dealers New & Used Electrical Materials  
Circuit Breakers/Motor Control/Buy & Sell  
2336 2a Av N -----Lethbridge 320-6077

**Electric Motors**

**CENTRAL ELECTRIC LTD**  
124 N Mayor Magrath Dr -----Lethbridge 327-5995  
**D A Electric Ltd**  
220 31 St N -----Lethbridge 328-4849  
Taber Ofc -----Taber 223-3600

Hagen Electric Ltd  
1202 2 Av S -----Lethbridge 328-8826  
(See Our Display Advertisement)

**LEESON ELECTRIC MOTORS—**  
AUTHORIZED SALES & SERVICE  
SOUTHERN REWIND LTD  
3522 9 Av N -----Lethbridge 328-9049

LONG DISTANCE  
APPOINTMENTS  
SAVE TIME & MONEY  
Avoid wasted trips,  
Allow better planning  
of your time.  
Make certain you are  
expected.  
Avoid long delays in  
waiting to see people.  
Enable your prospects  
to prepare for your visits.

**SOUTHERN REWIND LTD.**

**ELECTRICAL EQUIPMENT SALES & SERVICE**

*Rewind, Repair & Sales Of:*

- ELECTRIC MOTORS ● POWER PLANTS
- WELDERS ● POWER TOOLS ● PUMPS
- MOTOR CONTROLS & A.C. INVERTERS

**CERTIFIED TO REPAIR EXPLOSION-PROOF MOTORS**  
**DYNAMIC BALANCING**

**24 HOUR EMERGENCY SERVICE**

3522 - 9th AVE. NORTH  
LETHBRIDGE T1H 5E6



**328-9049**

**FAX 328-9371**

*Authorized Warranty For:*

- Baldor ● Armstrong ● WEG ● Lincoln
- Leeson ● Marathon Electric ● Hawker-Siddeley
- General Electric ● Newman ● U.S. Electric

**CENTRAL ELECTRIC LTD.**  
SINCE 1954

**AUTHORIZED WARRANTY DEPOT**

- Electric Motors
- Electric Generators
- Welder Repairs
- Electric & Pneumatic Tool Repairs

*Serving Southern Alberta Since 1954*

**327-5995**  
FAX 328-4124  
124 N. MAYOR MAGRATH DRIVE  
LETHBRIDGE

**MOTOR SALES**

**SERVICE**

**REPAIRS**

**INSTALLATIONS**

**Electricians (Cont'd)**

**AUTOMATED ELECTRIC SYSTEMS LTD**  
Variable Speed Drive Applications  
Pump Sales & Control Systems  
Process Automation & Instrumentation  
1420 31 St N -----Lethbridge 328-4400

**B & E CONTROL SERVICE**  
2926a 8 Av N -----Lethbridge 327-7733  
**B J D Electric Ltd**  
2404 2 Av N -----Lethbridge 320-5511  
(See Our Display Advertisement)

**BEEKEN ELECTRIC LTD**  
Commercial - Residential - Industrial  
Maintenance - Oilfield - Sales  
24 HOUR SERVICE  
Ranchland Mall -----Pincher 627-4677

**Bills Electric Coaldale Ltd**  
Box 946 -----Coaldale 345-3639  
Fax Line -----Coaldale 345-4717  
(See Our Display Advertisement)

**Bouchard Electric Ltd**  
6006 58 St -----Taber 223-8740

**Bridge Electric (1982) Ltd**  
1207 12c St N -----Lethbridge 328-9416  
(See Our Display Advertisement)

**Brouwer Electric Ltd**  
1822 10 St -----Coaldale 345-3337  
(See Our Display Advertisement)

**Cal's Electric**  
Lethbridge 380-4664  
(See Our Display Advertisement)

**Central Electric Ltd**  
124 N Mayor Magrath Dr -----Lethbridge 327-5995  
(See Our Display Advertisement)

**Clark's Electric**  
129 Main St N -----Milk River 647-3966

**CORONA ENVIRONMENT SYSTEMS LTD**  
3604 9 Av N -----Lethbridge 320-7726  
(See Our Display Advertisement)

**D A Electric Ltd**  
220 31 St N -----Lethbridge 328-4849  
(See Our Display Advertisement)

**Dabs Electric Ltd**  
1510b 31 St N -----Lethbridge 327-7201  
(See Our Display Advertisement)

**DORREN ELECTRIC 1985 LTD**  
226 22 St N -----Lethbridge 328-9246  
(See Our Display Advertisement)

**Dudas Electric Ltd**  
Lethbridge 327-3325  
(See Our Display Advertisement)

**ED'S ELECTRIC**  
1023 11 St S -----Lethbridge 329-8243

**Electric Energy**  
30 Laval Place W -----Lethbridge 381-1313  
J Gbb Res -----Lethbridge 381-1805

(CONTINUED NEXT LISTING PAGE)

**HAGEN ELECTRIC LTD.**

SERVING LETHBRIDGE & AREA OVER 40 YEARS



**Boy . . . Have We Got Motors**

COMPLETE ELECTRIC MOTOR REBUILDING  
REWIND - BEARINGS - SHAFT BUILD UP ETC....

- ALL TYPES OF MOTORS FOR FARM INDUSTRY & HOMES
- COMPLETE LINE OF PUMPS, MOTOR CONTROLS
- CPC CONSTANT PRESSURE CONTROL

**328-8826**

1202 - 2nd AVENUE SOUTH, LETHBRIDGE  
FAX 328-8600

**Electric Motors—Repairing**

**Central Electric Ltd**  
124 N Mayor Magrath Dr -----Lethbridge 327-5995  
(See Our Display Advertisement)

**HAGEN ELECTRIC LTD**  
1202 2 Av S -----Lethbridge 328-8826

**SOUTHERN REWIND LTD**  
3522 9 Av N -----Lethbridge 328-9049  
Fax Line -----Lethbridge 328-9371  
(See Our Display Advertisement)

**Star Electric & P T Sales Ltd**  
3504 64 Av SE -----Calgary 279-2650

**Electricians**

**Armax Electric Ltd**  
2924 12 Av N -----Lethbridge 320-7533  
(See Our Display Advertisement)

**ARTISAN ELECTRIC**  
RESIDENTIAL-FARM-COMMERCIAL-ALARM  
Sales-Industrial  
24 HOUR SERVICE  
Box 1891 -----Fort Macleod 553-2662

**Art's Electric**  
19 Kings Place S -----Lethbridge 327-2245  
(See Our Display Advertisement)

**4 GOOD REASONS FOR HANDLING COMPLAINTS BY LONG DISTANCE**

You can talk over matters at once. Promptness often prevents loss of a customer.  
You can build closer relations with customers.  
You can use tact in delicate situations. And because people talk more freely than they write, you can frequently trace the real reason for the complaint and prevent similar complaints in the future.

Every employee of the telephone company carries an identification card. We suggest that you refuse access to your premises to anyone who represents himself as from the telephone company, but who cannot so identify himself.



The  
Yellow Pages™  
Never out of sight

# B.J.D. ELECTRIC LTD.

- INDUSTRIAL
- COMMERCIAL
- FEED MILLS
- TRENCHING
- MAINTENANCE
- GRAIN ELEVATORS
- COMPUTERS
- ALARM SYSTEMS
- OILFIELD CONSTRUCTION

RADIO DISPATCHED  
**24 HOUR SERVICE**  
**"ELECTRICAL BY B.J.D."**

## 320-5511

FAX LINE 327-5399

2404 - 2nd AVE. N., LETHBRIDGE T1H 0C2

## ARMAX ELECTRIC LTD. LETHBRIDGE

# 320-7533

MEDICINE HAT 526-7525  
**24 HOUR SERVICE**

- OILFIELD ● INDUSTRIAL ● COMMERCIAL
- IRRIGATION ● TRENCHING ● MAINTENANCE

2924 - 12th AVE. N., LETHBRIDGE, ALBERTA T1H 5J9

## ART'S ELECTRIC

*"WE'LL LIGHT UP  
YOUR LIFE"*

- COMMERCIAL & RESIDENTIAL
- MAINTENANCE
- WIRING

## 327-2245

19 KINGS PLACE S., LETHBRIDGE

## CAL'S ELECTRIC

RESIDENTIAL - FARM  
COMMERCIAL  
• NEW INSTALLATIONS  
• MAINTENANCE  
• RENOVATIONS & ADDITIONS  
• REWIRE  
**FREE ESTIMATES**  
**380-4666**  
LETHBRIDGE  
*Plug Into Service & Quality*

# BILLS ELECTRIC COALDALE LTD.



SERVING ALL OF  
**SOUTHERN ALBERTA**

- RETAIL SALES
- FARM
- IRRIGATION
- COMMERCIAL
- RESIDENTIAL
- INDUSTRIAL
- ELECTRIC HEATING
- SERVICE MAINTENANCE
- UNDERGROUND WIRE
- LIGHTNING PROTECTIVE EQUIPMENT

**ELECTRICAL SUPPLIES AT WAREHOUSE PRICES**

## 345-3639

Box 946, Coaldale (1/2 Mile N. of Traffic Lights on 20th St.)

## BRIDGE ELECTRIC (1982) LTD.

- ★ INDUSTRIAL
  - ★ COMMERCIAL
  - ★ RESIDENTIAL
  - ★ MAINTENANCE
  - ★ FREE ESTIMATES
- 1207 - 12C ST. NORTH

## 328-9416

AFTER HOURS RES. 328-3024

## BROUWER ELECTRIC LTD.

- INDUSTRIAL
- RESIDENTIAL
- FARM WIRING
- MAINTENANCE

## 345-3337

LETHBRIDGE CELLULAR 382-9682  
1822 - 10th STREET, COALDALE

*Think it over,  
the decision  
becomes clear...*



Yellow Pages

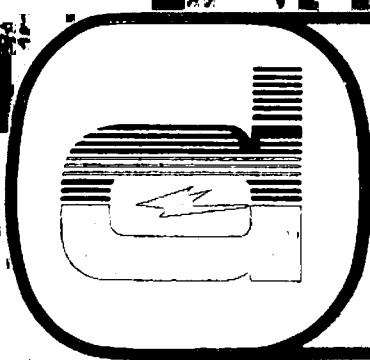
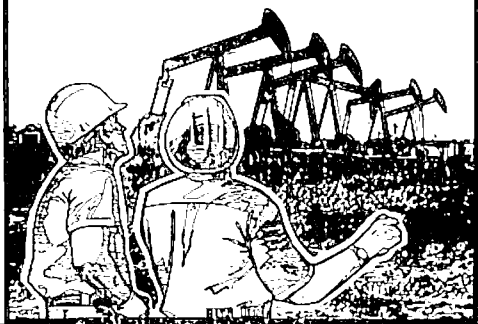

**D.A.  
ELECTRIC  
LTD.**

- ▲ OILFIELD
- ▲ COMMERCIAL
- ▲ INDUSTRIAL
- ▲ MAINTENANCE
- ▲ TRENCHING
- ▲ RIG WIRING
- ▲ GENERATOR RENTALS
- ▲ CABLE PLOWING
- ▲ MOBILE EQUIPPED
- ▲ MOTOR SUPPLIERS

**HEAD OFFICE LETHBRIDGE**

**328-4849**

**220 - 31st ST. N., LETHBRIDGE  
FAX: 327-3526**

**TABER**

**223-3600**

**5817 - 62nd STREET**

**CONSORT**

**577-2632**

**4904 - 49th STREET**

**24 HOUR SERVICE**

**CENTRAL  
ELECTRIC**

**LTD.**



**RADIO  
DISPATCHED**

**ELECTRICAL  
CONTRACTORS**

**24 HOUR  
SERVICE**

- COMMERCIAL
- INDUSTRIAL
- MAINTENANCE
- OILFIELD CONSTRUCTION
- TRENCHING

*Serving Southern  
Alberta Since 1954*

**327-5995**

**124 NORTH MAYOR MAGRATH DRIVE  
LETHBRIDGE**

**FAX 328-4124**

**ELECTRIC MOTOR  
SALES & SERVICE**

**ELECTRIC  
TOOL REPAIR**

**CORONA**  
*Environment Systems Ltd.*

**INDUSTRIAL — COMMERCIAL — FARM  
IRRIGATION — OILFIELD — RESIDENTIAL**

**SPECIALIZING IN ENERGY EFFICIENCY**

- CONSTANT PRESSURE CONTROL SYSTEMS
- PREMIUM EFFICIENT LIGHTING PRODUCTS
- POWER FACTOR CORRECTION
- CUSTOM CONTROL PANELS
- PREMIUM EFFICIENT MOTORS

*Toshiba*

CALL **320-7726**

**SERVING ALL OF SOUTHERN ALBERTA**

CALL **320-7754**

**24 HR. EMERGENCY SERVICE**

FAX LINE 329-8862

**3604 - 9th AVENUE NORTH, LETHBRIDGE**

# KING ELECTRIC

(LETHBRIDGE) LTD.

"SERVING LETHBRIDGE & SOUTHERN ALBERTA SINCE 1949"

- INDUSTRIAL
- COMMERCIAL
- RESIDENTIAL
- MAINTENANCE
- COMPUTER NETWORK CABLING
- FIRE ALARM SYSTEMS
- SECURITY SYSTEMS



## 329-1223

FAX: 328-9723



3509 - 6th AVENUE N., LETHBRIDGE

**DABS**  
ELECTRIC LTD.

ELECTRICAL  
CONTRACTORS  
24 HOUR  
SERVICE



## 327-7201

1510B - 31st St. N.,  
Lethbridge

## DUDAS ELECTRIC LTD.

- COMMERCIAL
- INDUSTRIAL
- RESIDENTIAL
- MAINTENANCE
- FIRE ALARM TESTING

## 327-3325

LETHBRIDGE  
24 HOUR EMERGENCY SERVICE

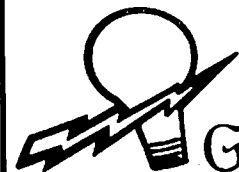

Galen  
Electric  
Residential, Farm, And  
Commercial Wiring

## 752-3860

GALEN BOURGOIN

Box 976  
Raymond, Alta. T0K 2S0

## HERB'S ELECTRIC

- RESIDENTIAL
- COMMERCIAL
- MAINTENANCE
- REWIRES
- FIRE ALARM TESTING & MAINTENANCE

FREE  
ESTIMATES  
HERB DYCK



## 345-3002

PAGER: 329-5759  
COALDALE

**DORREN**  
Electric

1985 LTD.

24 HOUR  
SERVICE

## 485-6344

VULCAN

## 328-9246

226 - 22nd STREET N.  
LETHBRIDGE  
FAX: 328-9783

- OILFIELD
- COMMERCIAL
- INDUSTRIAL
- RESIDENTIAL
- FARM WIRING
- MAINTENANCE
- BOOM TRUCK SERVICES

## ERIC'S ELECTRIC



- COMMERCIAL
- INDUSTRIAL
- RESIDENTIAL
- OILFIELD
- ALARMS ● HEATING
- VENTILATING ● CONTROLS
- MAINTENANCE

24 HOUR SERVICE  
ERIC MATIS

CELLULAR  
**380-0624**  
**328-3272**  
LETHBRIDGE

## KENNER ELECTRIC

CELLULAR  
382-0580

- ★ IRRIGATION & FARM
- ★ RESIDENTIAL
- ★ COMMERCIAL
- ★ SERVICE MAINTENANCE
- ★ COMPUTERIZED FEEDMILLS

KEN ROGALSKY

## 345-2222

1900 - 10th STREET, COALDALE, ALTA.  
WAREHOUSE - 1433 - 12th ST., COALDALE

## JUBILEE ELECTRIC

"QUALITY WITHOUT COMPROMISE"



SPECIALISTS  
IN:

- COMMERCIAL ● INDUSTRIAL
- RESIDENTIAL ● FARM
- FEED MILL WIRING
- FIRE ALARMS

Call Us For Prompt, Professional Service

## 327-8425

LETHBRIDGE

FREE  
ESTIMATES

## F.R.S. ELECTRIC LTD.

FOR RELIABLE SERVICE

- COMMERCIAL
- INDUSTRIAL
- MAINTENANCE
- MOTOR & BOILER CONTROLS

24 HR. EMERGENCY SERVICE  
FRANK WILKINSON

## 328-6860

FAX 328-6892  
3118 - 2nd AVE., N., LETHBRIDGE

## L.A. POWER SYSTEMS LTD.



Residential & Industrial  
Alarm Systems  
Sign Maintenance  
45 Foot Ladder Truck  
Trenching

## 328-6767

Fax 328-5094  
Box 2221, Lethbridge T1J 4K7

**Electricians (Cont'd)**

Eric's Electric -----Lethbridge 328-3272  
 (See Our Display Advertisement)  
 F R S Electric Ltd  
 3118 2 Av N -----Lethbridge 328-6860  
 (See Our Display Advertisement)  
 Foremost Electric -----Foremost 867-3539  
 Fyfe's Electric 1526 15 St N--Lethbridge 320-9111  
 Galen Electric Box 976 -----Raymond 752-3860  
 (See Our Display Advertisement)  
 Herb's Electric -----Coaldale 345-3002  
 (See Our Display Advertisement)  
 Hurkens Electric-----Picture Butte 732-4533  
**J B ELECTRIC**  
 525 6 Av W -----Cardston 653-4146  
 Jan's Electric Plumbing & Heating  
 222 6 St N -----Vauxhall 654-2234  
**JUBILEE ELECTRIC** ----Lethbridge 327-8425  
 (See Our Display Advertisement)  
 Kenner Electric 1900 10 St ----Coaldale 345-2222  
 (See Our Display Advertisement)  
**KING ELECTRIC (LETHBRIDGE) LTD**  
 3509 6 Av N -----Lethbridge 329-1223  
 (See Our Display Advertisement)  
**L A Power Systems Ltd**  
 Box 2221 -----Lethbridge 328-6767  
 (See Our Display Advertisement)  
**L & J Electric Ltd**  
 1210 3 Av N -----Lethbridge 328-2949  
 Laralindas Electric Ltd ----Lethbridge 329-6688  
 (See Our Display Advertisement)  
 Nav Electric 60 E 300 N-----Raymond 752-3793  
**NEU-LITE ELECTRIC INC**  
 2940 12 Av N -----Lethbridge 327-7711  
 Fax Line-----Lethbridge 329-3383  
 (See Our Display Advertisement)  
 Pioneer Electric (Lethbridge) Ltd  
 2014 22 Av S -----Lethbridge 327-6503  
 (See Our Display Advertisement)  
**PRECISION ELECTRIC (PINCHER CREEK) LTD**  
 Box 70 -----Pincher Creek 627-4611  
 Quest Electric & Alarm Services Ltd  
 1014 Ventura Cr N -----Lethbridge 328-4695  
 (See Our Display Advertisement)  
**RENNER'S ELECTRICAL SERVICES**-----Taber 223-4000  
**RIVERS ELECTRIC (TABER) CO LTD**  
 6007 54 Av -----Taber 223-4522  
 (See Our Display Advertisement)  
**SETSTAR ELECTRIC**  
 1714 24 St S-----Lethbridge 328-6812  
 Spectrum Installations -----Coaldale 345-4741  
 Fax Line-----Coaldale 345-2818  
 (See Our Display Advertisement)

(CONTINUED NEXT LISTING PAGE)

FIND WHAT YOU WANT —  
 WHEN YOU WANT IT —  
 PRODUCTS — DEALERS —  
 SERVICES — PROFESSIONS  
 are listed . . . by classification.  
 . . . throughout these pages. You  
 can find almost anything you  
 need quickly and easily when  
 you use THE YELLOW PAGES.



Want to  
 save  
 money?

Shop the  
 Yellow Pages™  
 for estimates

**PIONEER  
 ELECTRIC  
 (Lethbridge) LTD.**

- ★ COMMERCIAL
- ★ RESIDENTIAL
- ★ INDUSTRIAL

Phone or Fax  
**327-6503**

2014 - 22nd AVE. S.  
 LETHBRIDGE

**QUEST  
 ELECTRIC  
 & ALARM SERVICES LTD.**

- OILFIELD - CONTROLS
- COMMERCIAL - INDUSTRIAL
- RESIDENTIAL - MAINTENANCE
- SECURITY ALARMS
- 24 HR. SERVICE

Lethbridge  
**328-4695**

1014 Ventura Crescent North  
 Don Geddes - Pres.  
 Cellular 382-0405  
 Lethbridge Mobile XJ5-4208

**SPECTRUM  
 INSTALLATIONS**

- ELECTRICAL CONTRACTORS
- ENERGY CONSERVATION SPECIALISTS
- COMPLETE ENERGY ANALYSIS
- RETROFITS

- Commercial — Residential
- Farm — Maintenance
- Fire Alarm Systems
- and Maintenance
- Solid State Motor Controls
- Computer Networking
- Security Systems

**345-4741**

FAX LINE 345-2818  
 COALDALE



**RIVERS ELECTRIC  
 (TABER) CO. LTD.**

*“Growing and Expanding with the Industry”*

Commercial — Industrial  
 Oilfield, Farm & Residential Wiring

- SPECIALISTS IN ELECTRICAL IRRIGATION SYSTEMS
- TRENCHING ELECTRICAL PIVOT SYSTEMS
- INSTRUMENTATION FOR LOCATING BURIED CABLE & FAULTS

PRESIDENT ROY STEVENS

**223-4522**

6007 - 54th AVENUE, TABER



- DATA SYSTEMS
- COMPUTER NETWORKING
- MAINTENANCE
- INDUSTRIAL

- COMMERCIAL
- FIRE ALARM & CONTROL
- RESIDENTIAL

LARRY GATNER  
 MASTER ELECTRICIAN

**329-6688**

**TAMURA  
 ELECTRIC LTD.**



- Residential
- Commercial
- Service Maintenance

**381-1000**

9 CARLETON ROAD W.  
 LETHBRIDGE



2940 - 12th AVE. N.  
 LETHBRIDGE

**327-7711**

FAX LINE: 329-3383

- COMMERCIAL
- RESIDENTIAL
- FIRE ALARM SYSTEMS
- FARM
- TRENCHING & BACKHOE
- COMPUTER NETWORKING



**Electricians (Cont'd)**

Tamura Electric Ltd  
9 Carleton Rd W -----Lethbridge 381-1000  
(See Our Display Advertisement)  
Trockstad Electric -----Lethbridge 329-0617  
Fax Line -----Lethbridge 329-8160  
Van Rijn Electric Ltd  
31907 18 Av -----Coaldale 345-5820  
(See Our Display Advertisement)  
Van's Electric  
3015c 12 Av N -----Lethbridge 380-2253  
(See Our Display Advertisement)

There's no business  
like "Show Business" -  
and these "Yellow Pages"  
"Show" You The Business  
In Your City.

**Electricians (Cont'd)**

Vulcan Electrical Ltd  
6008 60 Av -----Taber 223-8276  
Westwind Electric Co  
436 22 St -----Fort Macleod 553-2248  
**WYATT ELECTRIC LTD**  
COMMERCIAL - RESIDENTIAL  
BOOM TRUCK & SIGN SERVICE  
SINCE 1945  
3020 12 Av N -----Lethbridge 327-2048

Who makes it —  
Who sells it —  
Who services it —  
These YELLOW PAGES list them  
all conveniently by business  
classification.

**Electrolysis**

Crystal Image Electrolysis  
1205 3 Av S -----Lethbridge 320-9120  
(See Our Display Advertisement)

**FACE FACTS**

ELECTROLYSIS, THERMOLYSIS & THE BLEND  
CALL ROSE FOR YOUR COMPLIMENTARY  
CONSULTATION & SAMPLE  
509 7 St S -----Lethbridge 320-9493

**PEACHES 'N CREAM ELECTROLYSIS**

JOCELYN ORR, CERTIFIED ELECTROLOGIST  
-COMPLIMENTARY CONSULTATION & SAMPLE  
-DAY & EVENING APPOINTMENTS  
2215 2 Av -----Fort Macleod 553-2425

Pride Electrolysis  
455 Sandman Inn Plaza -----Lethbridge 328-5683  
(See Our Display Advertisement)

Soft Touch Electrolysis & Reflexology  
180 S 200 W -----Raymond 752-3100

**Crystal Image**  
**Electrolysis**  
CONFIDENTIAL  
PERMANENT HAIR REMOVAL  
FOR MEN & WOMEN  
OFFERING ELECTROLYSIS, THERMOLYSIS & THE BLEND  
Specializing In:  
• ALL BODY HAIR  
• BIKINI LINES  
• REASONABLE RATES  
REGISTERED & EXPERIENCED ELECTROLOGIST  
MONDAY - FRIDAY 9:30 - 5:30  
(Evenings On Request)  
**320-9120**  
1205 3RD AVE. S., LETHBRIDGE



**FREEDOM FROM UNWANTED HAIR FOREVER**  
THE BLEND GIVES EXCELLENT RESULTS  
• SHORTWAVE-THERMOLYSIS METHOD AVAILABLE  
• CLEAN PROFESSIONAL SURROUNDINGS  
WITH REASONABLE RATES  
**PRIDE ELECTROLYSIS & OBSESSIONS HAIR DESIGN**  
455 SANDMAN INN PLAZA  
MAYOR MAGRATH DR. S., LETHBRIDGE  
**328-5683**  
EDIE TAYLOR  
Registered Electrologist  
with 16 years experience

**Electronic Equipment & Supplies**

Radio Shack Park Place -----Lethbridge 329-1012  
Lethbridge Centre -----Lethbridge 328-9166

**Electronic Equipment & Supplies Repairing**

H L Electronics 723 29 St N -----Lethbridge 320-5638  
**INNOVEX INSTRUMENTATION SPECIALTIES LTD**  
Medical, Laboratory & Computer Repair  
NIST CALIBRATIONS  
9 5918 5 St SE -----Calgary 259-4332

Weather shouldn't worry you  
When a shopping trip is due.  
You can shop and yet be dry  
WHEN "YELLOW PAGES" ARE  
NEARBY.

**Electronic Equipment & Supplies-Wholesale & Mfrs**

Alpha Tec Tron Systems Ltd  
316 34 St S -----Lethbridge 328-2230

**CARDINAL INDUSTRIAL ELECTRONICS (1992) LTD**  
SERVING CANADIANS  
COAST TO COAST  
(No Charge Dial) -----1-800-661-1475

**HI-TECH COMPONENTS LTD**  
MANUFACTURER OF  
PRINTED WIRE CIRCUIT BOARDS  
COMMERCIAL REPAIRS FAX: 328-6244  
215 12b St S -----Lethbridge 329-0252

**ROSS ELECTRONICS LTD**  
3006 2 Av N -----Lethbridge 327-1933  
**TITAN WHOLESALE DISTRIBUTORS LTD**  
532 36 St N -----Lethbridge 320-1211

**Electronic Testing Equipment**

G E RENTAL/LEASE  
(No Charge Dial) -----1-800-437-3687

**Elevators—Passenger & Freight**

**DOVER ELEVATORS CANADA**

ELEVATORS  
ESCALATORS  
HANDICAP LIFTS  
MAINTENANCE  
MODERNIZATION  
REPAIRS  
FAST & DEPENDABLE SERVICE  
**DOVER**  
SALES & SERVICE CALL  
Dover Elevator  
4 6320 11 St SE -----Calgary 259-4183

(CONTINUED NEXT LISTING PAGE)

**USE THE INDEX**

**ELCOR ELEVATOR SERVICES CORPORATION**

ELEVATORS	MAINTENANCE
ESCALATORS	MODERNIZATION
HANDICAPPED LIFTS	REPAIRS
24 HOUR SERVICE	DUMBWAITERS
LICENCED TO PERFORM Gov't. Safety Exams.	SUPPLY & INSTALLATION

**381-1707**  
FAX LINE CALGARY 287-3835  
LETHBRIDGE

**OTIS Canada Inc.**



- Installation
- Maintenance
- Repair & Modernization
- For Elevators, Escalators
- Dumbwaiters, Residential Elevators & Handicap Lifts

24 Hours a Day Our Innovative New Otisline is Ready to Serve You

**GOVERNMENT SAFETY EXAMINATION REPORTS**

3514b 6 Ave. N.  
**327-1666**  
Or No Charge - Dial  
1-800-233-6847

**Van Rijn Electric Ltd.**

Commercial - Industrial - Farm - Residential  
Maintenance - Instrumentation - Power Factor Correction  
Ground Fault Detection In Underground Systems  
Constant Pressure Control Systems

"Let us make short work of your underground wiring problems"

SPECIALIZING IN:  
• ELECTRICAL FOR IRRIGATION  
• GROUND FAULT LOCATION IN UNDERGROUND POWER SYSTEMS FOR IRRIGATION & FARM

24 HOUR EMERGENCY SERVICE **345-5820** FREE ESTIMATES

HANK VAN RIJN RES: 345-4370 **382-0098** Cellular Phone  
JACK VAN RIJN RES: 345-3733 **382-0099** Cellular Phone  
#3, 1907 - 18th AVE., COALDALE, ALBERTA T1M 1K7  
"Our Service is Electrifying"  
FAX LINE: 345-5821



**VAN'S ELECTRIC**  
3015C - 12th Ave. N., Lethbridge



• Commercial • Residential  
• Industrial • Maintenance  
• Fire Alarm Installation & Testing

Lawrence Van Egmond  
Master Electrician  
26 Yrs. Experience

After Hours  
Emergency Res. **381-7914**  
Free Estimates  
**380-2253**

**Elevators—Passenger & Freight (Cont'd)**

**Ecor Elevator Services Corporation**  
Lethbridge 381-1707  
(See Our Display Advertisement)

**MONTGOMERY KONE ELEVATOR CO LIMITED**  
24 666 Goddard Av NE ----- Calgary 275-5650  
**Otis Canada Inc**  
3514b 6 Av N ----- Lethbridge 327-1666  
(See Our Display Advertisement)

**RAM MANUFACTURING LTD**  
★ ELEVATORS FOR PHYSICALLY DISABLED  
COMMERCIAL & RESIDENTIAL  
ALBERTA MANUFACTURER  
GOVERNMENT APPROVED  
Toll Free ----- Edmonton 1-800-563-4382

**Schindler Elevator Corporation**  
Lethbridge 328-7848  
(See Our Display Advertisement)

**4 GOOD REASONS FOR HANDLING COMPLAINTS BY LONG DISTANCE**  
You can talk over matters at once. Promptness often prevents loss of a customer.  
You can build closer relations with customers.  
You can use tact in delicate situations. And because people talk more freely than they write, you can frequently trace the real reason for the complaint and prevent similar complaints in the future.

**Schindler Elevator Corporation**

- ELEVATORS
- ESCALATORS
- MODERNIZATION
- MAINTENANCE/ REPAIRS
- 24 HOUR SERVICE

**328-7848**  
Lethbridge, Alta.

**Schindler**

for your shopping convenience  
**WE'RE OPEN ALL NIGHT!**



Yellow Pages

**Elevators—Repairing**

**Otis Canada Inc**  
3514b 6 Av N ----- Lethbridge 327-1666  
**SCHINDLER ELEVATOR CORPORATION**  
Lethbridge 328-7848

**Embroidery**

**Chinook Embroidery**  
2921 12 Av N ----- Lethbridge 320-6639  
(See Our Display Advertisement)  
**INITIAL IMAGES LTD**  
1629 Cedar Rd S ----- Lethbridge 327-2788  
**Tex-Style Sportswear** ----- Lethbridge 320-9443  
(See Our Display Advertisement)

**Your Good Name Deserves To Look Great With Embroidered Items**



**CRESTS • CUSTOM DESIGNS STOCK DESIGNS**

**CHINOOK EMBROIDERY**

*Call Now!*  
**320-6639**  
2921 - 12th Ave. N., Lethbridge



**TEX-STYLE SPORTSWEAR**

- ★ SILK SCREENING
- ★ EMBROIDERY
- ★ T-SHIRTS
- ★ CAPS
- ★ JACKETS
- ★ TEAM UNIFORMS

**320-9443**  
LETHBRIDGE  
**345-5838**  
1905 - 18th ST., COALDALE

**Emergency Medical Clinics**

**Blood Tribe Community Health Centre**  
Community Health Centre Bldg ----- Standoff 737-3888  
**Family Medical Centre**  
2931 20 Av S ----- Lethbridge 328-2326

**Employee Plans—Consultants**

**ALBERTA DENTAL SERVICE CORPORATION**  
(No Charge Dial) ----- 1-800-232-1997

**Employment Agencies**

**ACCESS 45 EMPLOYMENT SERVICE**  
A FREE  
EMPLOYMENT REFERRAL SERVICE  
FOR PEOPLE OVER 45  
FUNDED BY  
THE GOVERNMENT OF ALBERTA  
126 909 3 Av N ----- Lethbridge 329-9150

**Agricultural Employment Services**  
2 Fir Post Office Bldg ----- Lethbridge 327-1822  
Fax Line ----- Lethbridge 327-8140  
Sub Ofc ----- Taber 223-2222

**Employment Agencies (Cont'd)**

**CAREER MARKETPLACE CANADA**  
WHERE EMPLOYERS & EMPLOYEES MEET!  
• CAREER REGISTRY & JOB HOTLINE  
• RESUME PREPARATION & DISTRIBUTION  
Box 221 ----- Lethbridge 327-9675

**Dominion Automobile Association**  
329 Laval Blvd W ----- Lethbridge 381-0441

**HIRE-A-STUDENT**  
Employment Referral Service  
For Students  
619 4 Av S ----- Lethbridge 380-4473

**LETHBRIDGE & DISTRICT YOUTH EMPLOYMENT CENTRE**  
EMPLOYMENT REFERRAL SERVICE  
FOR YOUTHS 15-24 YEARS OF AGE  
619 4 Av S ----- Lethbridge 329-3555

**Manpower Temporary Services** ----- Lethbridge 328-7272

**PEAK PERFORMANCE SERVICES**  
200 120 8 St S ----- Lethbridge 329-1262

**PERSONAL RESUMES INTERNATIONAL**  
FOR POSITIONS IN LETHBRIDGE  
ACROSS CANADA, U.S.A. & OVERSEAS  
EVENINGS, RES. 277-1787  
907 610 8 Av SW ----- Calgary 262-6829

**T N S PERSONNEL SERVICES LTD**  
1222 3 Av S ----- Lethbridge 329-9090

**Employment—Career Counselling**

**LETHBRIDGE FAMILY SERVICES**  
**DaCapo Program**  
-Specializing in work experience & in-facility contract assembly work  
-Head injured & Mentally Handicapped Adults  
1107 2a Av N ----- Lethbridge 327-5724

**Native Employment Services Association Of Alberta** 1271 3 Av S ----- Lethbridge 320-9010  
Fax Line ----- Lethbridge 320-2189

**YOU'RE WORTH IT - JOB GENERATION PROGRAM**  
515 Stafford Dr S ----- Lethbridge 328-1338

**Employment—Temporary**

**Manpower Temporary Services** ----- Lethbridge 328-7272  
**T N S Personnel Services Ltd**  
1222 3 Av S ----- Lethbridge 329-9090  
(See Our Display Advertisement)

Every employee of the telephone company carries an identification card. We suggest that you refuse access to your premises to anyone who represents himself as from the telephone company, but who cannot so identify himself.

**Encyclopedias**

**WORLD BOOK EDUCATIONAL PRODUCTS**  
3331 23 St NE ----- Calgary 250-2741

**Energy Conservation Consultants**

**SPECTRUM INSTALLATIONS**  
Complete Electrical Energy Analysis  
Conservation Retrofits That Save Energy AND Money!  
----- Coaldale 345-4741

**Engineers—Civil**

**Associated Engineering Alberta Ltd**  
300 410 Stafford Dr S ----- Lethbridge 329-1404

**Engineers—Consulting**

**Al's Oilfield Supervision Services (1991) Ltd** ----- Taber 223-1636  
Res ----- Taber 223-3478

**ASSOCIATED ENGINEERING ALBERTA LTD**  
300 410 Stafford Dr S ----- Lethbridge 329-1404  
**Association Of Professional Engineers Geologists & Geophysicists Of Alberta**  
Edmonton (Toll Free) ----- 1-800-661-7020  
(See Our Display Advertisement)

**BOHNERT ENGINEERING SERVICES LTD**  
Consulting Engineers  
P.O. Box 785, Lethbridge  
8 Coalmine ----- Lethbridge 381-6699

**Campbell Woodall & Associates Consulting Engineers Ltd** 206 31 St N ----- Lethbridge 327-0107

**E B A ENGINEERING CONSULTANTS LTD**  
Foundation Investigation and Design  
Material Testing And Inspection  
Aggregate Concrete Asphalt Soil  
Environmental Assessment And Engineering  
FAX 328-8817  
442 10 St N ----- Lethbridge 329-9009

**H B T Agra Limited**  
1430b 31 St N ----- Lethbridge 327-7474  
Fax Line ----- Lethbridge 327-7682

**HARDY B B T LIMITED** - See H B T Agra Limited

**Hasegawa Engineering**  
Box 1250 Raymond ----- Lethbridge 328-2686  
(See Our Display Advertisement)

**M P E ENGINEERING LTD**  
2220 5 Av S ----- Lethbridge 329-3442  
Fax Line ----- Lethbridge 329-9354

(CONTINUED NEXT LISTING PAGE)

IS EACH LINE OF YOUR BUSINESS UNDER THE APPROPRIATE "YELLOW PAGES" HEADING?

**PERSONABLE PERSONNEL.**  
1222 Third Avenue South  
Lethbridge, Alberta T1J 0J9

Guaranteed Permanent & Temporary Placements.

- SECRETARIAL
- LABOUR
- ACCOUNTING
- TRADES
- OFFICE SUPPORT
- SALES

**TNS Ltd**  
**PERSONNEL SERVICES**

**329-9090**  
**FAX: 329-4139**

**uma****Engineering Ltd.****Committed To Client Satisfaction Through Total Quality Management**

- Agri-Industrial Services
- Environmental Services
- Electrical & Instrumentation
- Programmable Controllers
- Land Development Services
- Municipal Services
- Commercial Turf Irrigation
- Resource Development Regional & Rural Planners
- Surveys, Mapping and G.I.S.
- Transportation Systems
- Water Resources and Irrigation

**329-4822**

FAX: 329-1678  
514 Stafford Drive North  
Lethbridge, T1J 3Z4

**APEGGA**

The Association of  
Professional Engineers, Geologists  
and Geophysicists of Alberta

**EMPOWERED BY GOVERNMENT TO  
REGULATE THE PRACTICE OF  
ENGINEERING IN ALBERTA**

When contracting professional engineering services, check with us to ensure you are hiring a licensed individual or organization. Only APEGGA members are legally authorized to practice engineering in Alberta.

APEGGA  
15th Floor, Scotla Place, Tower 1  
10060 Jasper Avenue

Edmonton.....426-3990  
Toll-Free Within Alberta.....1-800-661-7020

**Reid Crowther**

Structural • Mechanical • Electrical  
Industrial Buildings • Planning • Arctic  
Services • Environmental • Municipal  
Transportation • Energy Conservation  
Pollution Control • Waste Management

**Reid Crowther & Partners Ltd.**  
Engineers • Planners • Scientists

202, 714 - 5th Avenue S.  
Lethbridge, Alta.

**328-5468**

FAX 320-5985

**HBT AGRA  
Limited**

- GEOTECHNICAL ENGINEERING
- MATERIAL ENGINEERING
- ENVIRONMENTAL SERVICES
- CONTAMINANT SCIENCES
- SURFACE & GROUND WATER RESOURCES
- SOILS & MATERIALS TESTING
- BUILDING SCIENCES
- CHEMICAL SCIENCES
- MINING EXPERTISE

**327-7474**

1430B - 31 St. North  
LETHBRIDGE

**AGRA**  
Earth & Environmental Group

**Stanley**

- Transportation
- Structural
- Mechanical
- Electrical
- Municipal
- Waste Management
- Project Management
- Environmental
- Water Resources

**Stanley Associates  
Engineering Ltd.**  
407 Mayor Magrath Dr. S  
329-3344 Lethbridge  
Fax 328-0664

**HE HASEGAWA  
ENGINEERING**

- MUNICIPAL
- STRUCTURAL
- ENVIRONMENTAL
- PROJECT MANAGEMENT
- FOUNDATION DESIGN (PWF)
- SURFACE WATER & GROUND WATER MANAGEMENT

**328-2686**

LETHBRIDGE

FAX LINE 752-4701

Box 1250 Raymond  
Alberta T0K 2S0



There's a cause for  
everyone ...  
**YOUR GUIDE TO GIVING  
AND VOLUNTEERING**

Refer to the Charity Guide  
under the  
"Charitable & Non-Profit  
Organizations" Yellow  
Pages Heading.

**Engineers-Consulting (Cont'd)**

**MARTIN GEOMATIC CONSULTANTS LTD**  
CONSULTING ENGINEERS  
SURVEY ENGINEERS  
LAND SURVEYORS  
Municipal, Civil, Planning,  
Development Consultants

436 10 St N .....Lethbridge 329-0050

Reid Crowther & Partners Limited  
202 714 5 Av S .....Lethbridge 328-5468  
Fax .....Lethbridge 320-5985

(See Our Display Advertisement)

**RING IRRIGATION ENGINEERING**  
Box 703 .....Raymond 752-4383

**STANLEY ASSOCIATES ENGINEERING LTD**  
407 Mayor Magrath Dr S .....Lethbridge 329-3344  
(See Our Display Advertisement)

**TORCHINSKY ENGINEERING LTD**

**HIGHWAY ENGINEERING  
ROAD ENGINEERING**

PRELIMINARY ENGINEERING, DESIGN &  
PROJECT SUPERVISION & MANAGEMENT  
CALGARY OFC 253-2560

421 33 St N .....Lethbridge 329-1467

**U M A ENGINEERING LTD**

514 Stafford Dr N .....Lethbridge 329-4822

(See Our Display Advertisement)

**Engineers-Electrical****REID CROWTHER & PARTNERS LIMITED**

202 714 5 Av S .....Lethbridge 328-5468

Wiebe Forest Engineering  
1510g 31 St N .....Lethbridge 380-3851

**Engineers-Environmental**

**E B A ENGINEERING CONSULTANTS LTD** 442 10 St N .....Lethbridge 329-9009

**H B T AGRA LIMITED** 1430b 31 St N .....Lethbridge 327-7474

**REID CROWTHER & PARTNERS LIMITED** 202 714 5 Av S .....Lethbridge 328-5468

**Engineers-Foundation**

**E B A ENGINEERING CONSULTANTS LTD** 442 10 St N .....Lethbridge 329-9009

**Engineers-Inspecting & Testing**

**E B A ENGINEERING CONSULTANTS LTD** 442 10 St N .....Lethbridge 329-9009

**H B T AGRA LIMITED** 1430b 31 St N .....Lethbridge 327-7474

**Engineers-Mechanical**

**REID CROWTHER & PARTNERS LIMITED** 202 714 5 Av S .....Lethbridge 328-5468

Wiebe Forest Engineering  
1510g 31 St N .....Lethbridge 380-3851

**Engineers-Municipal**

**REID CROWTHER & PARTNERS LIMITED** 202 714 5 Av S .....Lethbridge 328-5468

**Engineers-Structural**

**CAMPBELL WOODALL & ASSOCIATES CONSULTING ENGINEERS LTD** 206 31 St N .....Lethbridge 327-0107

Hasegawa Engineering  
Box 1250 Raymond .....Lethbridge 328-2686

**REID CROWTHER & PARTNERS LIMITED** 202 714 5 Av S .....Lethbridge 328-5468

FIND IT HERE FIRST

**Engineers-Water Resources**

**M P E ENGINEERING LTD**  
2220 5 Av S .....Lethbridge 329-3442

**Engines-Diesel**

**ABLE TRUCK & TRAILER REPAIRS**  
TUNE-UPS & ENGINE REPAIRS  
(NO CHARGE DIAL) 1-800-267-2999  
Licensed Alberta Safety Inspection Station  
2345 2A Av N .....Lethbridge 327-2626

**ALBERTA ENGINE & PARTS LTD**  
DIESEL ENGINE SPECIALISTS

3801c 16 St SE Calgary  
(No Charge Dial) .....1-800-361-7333

**Brown Tractor & Equipment Inc**  
1510 33 St N .....Lethbridge 320-1522

(See Our Display Advertisement)

**C E M Heavy Equipment Repairs Ltd**  
6211 52 Av .....Taber 223-4683  
Fax Line .....Taber 223-3682

**CATERPILLAR DIESEL ENGINES**

INDUSTRIAL -  
MARINE - TRUCK  
GENERATOR SETS  
85 - 7,300 HP,  
60 - 5720 KW  
Engineered, Installed,  
Serviced

**"FOR INFORMATION CALL"**

**AUTHORIZED DEALERS**  
Fining Power Systems  
717 5 Av N .....Lethbridge 328-3366

(CONTINUED NEXT LISTING PAGE)

A BEDROOM TELEPHONE brings you comfort and security at night.

**BROWN TRACTOR & B.T.E. EQUIPMENT INC.**

The Diesel Engine Parts Centre  
Where Quality Costs Less

Authorized Distributor For **BERRY INDUSTRIES INC.**

Heavy Duty Engine Parts For  
DETROIT DIESEL CUMMINS  
CATERPILLAR & OTHERS  
DEALER WHOLESALE  
& FLEET

No Charge Dial  
**1-800-665-2959**

320-1522  
1510 - 33rd ST. N., LETHBRIDGE

**FISHER DIESEL INJECTION SERVICES LTD.**

FACTORY AUTHORIZED WARRANTY AND SERVICE

SPECIALISTS IN FUEL INJECTION REPAIRING

TURBOS INSTALLED

DRIVE-IN FACILITIES

AUTOMOTIVE, AGRICULTURE, INDUSTRIAL

**327-0711**

Fax 320-5464

2903 - 7th Ave. North  
Lethbridge, Alta. T1H 5C5

**Engines-Diesel (Cont'd)**

**CUMMINS DIESEL ENGINES**

COMPLETE LINE FOR ALL APPLICATIONS

- Automotive, Industrial, Construction, Agriculture, Marine, Generator Sets.
- Genuine Cummins Parts & Service



**DISTRIBUTORS**  
Cummins Alberta  
230 24 St N -----Lethbridge 329-6144

**DEUTZ ENGINES-  
DISTRIBUTOR SALES & SERVICE  
SIMON-MAXWELL LTD**  
6447 2 St SE -----Calgary 252-8131

**Fisher Diesel Injection Services Ltd**  
2903 7 Av N -----Lethbridge 327-0711  
(See Our Display Advertisement)

**G C L DIESEL INJECTION SERVICE LTD**  
9 4041 74 Av SE -----Calgary 279-2368

**ISUZU DIESEL ENGINES-  
AUTHORIZED DEALERS  
WALLY'S IRRIGATION SERVICES (1985)  
LIMITED**  
4314 1 Av S -----Lethbridge 328-9382

**Kootenay Fuel Injection Inc**  
426 Van Home S Cranbrook BC (No Charge Dial)  
-----Lethbridge 327-0711  
(See Our Display Advertisement)

**Lethbridge Diesel Ltd**  
1705 31 St N -----Lethbridge 328-1168  
(See Our Display Advertisement)

**STANADYNE/ROOSA MASTER FUEL INJECTION SERVICE-  
AUTHORIZED DEALERS  
FISHER DIESEL INJECTION SERVICES LTD**  
2903 7 Av N -----Lethbridge 327-0711  
**TABER DIESEL SERVICES LTD**  
6009 56 Av -----Taber 223-9636

**Engines-Diesel (Cont'd)**

**TABER DIESEL SERVICES LTD**

**T D S**  
Qualified Specialist in:  
**FUEL INJECTION  
&  
TURBO CHARGING**  
Complete Diesel Tune-up Service  
Authorized Factory Warranty & Service  
6009 56 Av -----Taber 223-9636

**WESTERN DIESEL WHOLESALE LTD**  
(No Charge Dial) -----1-800-442-8733

**Engines-Gasoline**

**BRIGGS & STRATTON GASOLINE ENGINES**

Authorized Service Centers- factory-trained personnel- special tools- original equipment parts- dependable courteous service.



*"FOR INFORMATION CALL"*  
**SERVICE DEALERS**  
**CARDSTON**  
Southern Equipment Ltd  
775 2 Av E -----Cardston 653-4941  
**CLARESHOLM**  
Claresholm Power Products  
427 43 Av E -----Claresholm 625-3090  
**FOREMOST**  
Foremost Fertilizers Ltd  
Box 458 -----Foremost 867-3535  
**FORT MACLEOD**  
Williamson Ed Motorcycle & Small Engine Repair  
610 12 St -----Fort Macleod 553-3828  
**LETHBRIDGE**  
McKay Bros Farm Implements Ltd  
3214 5 Av N -----Lethbridge 327-5512  
Niels & Gord's Lawn Mower & Small Engine Repair  
326b 10 St N -----Lethbridge 328-9178  
**PICTURE BUTTE**  
Butte Motors & Farm Supply Ltd  
320 Highway Av N -----Picture Butte 732-4406  
**TABER**  
Mower Magic 5501 47 Av ---Taber 223-1027  
**VAUXHALL**  
Hardens Supply  
432 2 Av N -----Vauxhall 654-2121

**Butte Motors & Farm Supply Ltd**  
320 Highway Av N -----Picture Butte 732-4406  
(See Our Display Advertisement)

**Custom Engine & Parts Limited**  
316 34 St S -----Lethbridge 328-8181

**D D K Lawn & Garden Equipment**  
2910 16 Av N -----Lethbridge 327-8080

**ED WILLIAMSON MOTORCYCLE & SMALL ENGINE REPAIR**  
610 12 St -----Fort Macleod 553-3828

**HONDA POWER EQUIPMENT**

- Gasoline Powered
- General Purpose Engines



*"FOR INFORMATION CALL"*  
**AUTHORIZED DEALERS**  
Butte Motors & Farm Supply Ltd  
320 Highway Av N -----Picture Butte 732-4406  
Hardens Supply  
432 2 Av N -----Vauxhall 654-2121  
Lethbridge Honda Suzuki Centre  
1117 2 Av S -----Lethbridge 327-8889  
Williamson Ed Motorcycle & Small Engine Repair  
610 12 St -----Ft Macleod 553-3828

**Engines-Gasoline (Cont'd)**

**KOHLER ENGINES**

Factory-trained personnel.  
Genuine Kohler Parts.  
Magnum and Command horizontal and vertical shaft engines - for all types of powered equipment.



*"FOR INFORMATION CALL"*  
**SERVICE DEALERS**  
**CARDSTON**  
Southern Equipment Ltd  
775 2 Av E -----Cardston 653-4941  
**CLARESHOLM**  
Claresholm Power Products  
427 43 Av E -----Claresholm 625-3090  
**FORT MACLEOD**  
Williamson Ed Motorcycle & Small Engine Repair  
610 12 St -----Fort Macleod 553-3828  
**LETHBRIDGE**  
Custom Engine & Parts Limited  
316 34 St S -----Lethbridge 328-8181  
**MILK RIVER**  
Ridge Parts  
1131 Av NW -----Milk River 647-3933  
**PICTURE BUTTE**  
Butte Motors & Farm Supply Ltd  
320 Highway Av N -----Picture Butte 732-4406  
**TABER**  
Mower Magic 5501 47 Av ---Taber 223-1027  
**VAUXHALL**  
Hardens Supply  
432 2 Av N -----Vauxhall 654-2121  
**CENTRAL DISTRIBUTORS**  
**CALGARY**  
Lotus Equipment Sales Ltd  
Bay 120 5726 Burleigh Cr SE --Calgary 253-0822

**Lethbridge Honda Centre Ltd**  
1117 2 Av S -----Lethbridge 327-2777  
(See Our Display Advertisement)

**Lethbridge Kawasaki Ltd**  
3040 13 St N -----Lethbridge 327-6117  
(See Our Display Advertisement)

**Niels & Gord's Lawn Mower & Small Engine Repair**  
326b 10 St N -----Lethbridge 328-9178  
(See Our Display Advertisement)

**ONAN AIR & WATER COOLED ENGINES--  
DISTRIBUTOR-SALES & SERVICE  
SIMON-MAXWELL**  
6447 2 St SE -----Calgary 252-8131

**TECUMSEH ENGINES & TRANSMISSIONS**

- FOR HOME & INDUSTRY
- Over-Head Valve, XL Xtra Life, Replacement Engines
- Factory Service
- Genuine Parts - Trained Mechanics



*"FOR SERVICE CALL"*  
**REGISTERED SERVICE DEALERS**  
**CLARESHOLM**  
Claresholm Power Products  
427 43 Av E -----Claresholm 625-3090  
**LETHBRIDGE**  
Master Farm Supply  
320 Highway Av N -----Picture Butte 732-4406  
**MCKAY BROS FARM IMPLEMENTS LTD**  
3214 5 Av N -----Lethbridge 327-5512  
Niels & Gord's Lawn Mower & Small Engine Repair  
326b 10 St N -----Lethbridge 328-9178  
**PICTURE BUTTE**  
Butte Motors & Farm Supply Ltd  
320 Highway Av N -----Picture Butte 732-4406  
**TABER**  
Mower Magic 5501 47 Av ---Taber 223-1027

(CONTINUED NEXT LISTING PAGE)

IS EACH LINE OF YOUR BUSINESS UNDER THE APPROPRIATE "YELLOW PAGES" HEADING?

\*\*\*\*\*

## BUTTE MOTORS

& FARM SUPPLY LTD.



**KOHLER engines**



**HONDA Power Equipment**

● WISCONSIN ● KAWASAKI  
★ SMALL ENGINE REPAIRS  
★ CHAIN SAW SPECIALISTS

### 732-4406

320 HIGHWAY AVE. N., PICTURE BUTTE

\*\*\*\*\*

\*\*\*\*\*

## LETHBRIDGE HONDA CENTRE LTD.

### WORLD'S LARGEST MFR.

4 H.P. TO 20 H.P.  
ELECTRIC & PULL START  
REPLACEMENT ENGINES  
FOR MOST FARM &  
INDUSTRIAL USAGE



### 327-2777





1117 - 2nd AVE. S., LETHBRIDGE

\*\*\*\*\*

## Kootenay ABS FUEL INJECTION INC.

ASSOCIATION OF DIESEL SPECIALISTS

AUTHORIZED SALES & SERVICE

Complete Repairs On All Makes Of  
DIESEL FUEL PUMPS/TURBO CHARGERS  
DIESEL/GAS FUEL INJECTORS

NO CHARGE DIAL  
1-800-661-1322

426 Van Home S.  
Cranbrook, B.C. V1C 4W7  
(See Our Ad Under TURBOCHARGERS)

## LETHBRIDGE DIESEL LTD.

Authorized  
PARTS & SERVICE  
Full Line Dealer



Detroit Diesel



VOLVO GM CANADA Heavy Truck



Allison Transmission

### 328-1168

FAX: 328-1110  
1705 - 31st STREET N., LETH.

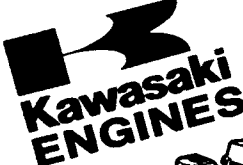

## Kawasaki ENGINES

- 1.7 HP to 20 HP
- FOUR CYCLE
- SPECIAL FARM PRICES

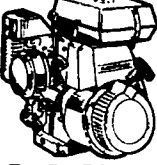

### 327-6117

LETHBRIDGE KAWASAKI LTD.  
3040 - 13th ST. N., LETHBRIDGE

MOTORCYCLES & TRIMMERS

## Niels & Gord's

### LAWN MOWER & SMALL ENGINE REPAIR PARTS & SERVICE FOR:









FREE PICK-UP & DELIVERY

### 328-9178

326B - 10th ST. N.  
LETHBRIDGE

WHEEL MOVE ENGINES • TILLERS

**Engines—Gasoline (Cont'd)**

**WISCONSIN & WISCONSIN ROBIN GASOLINE ENGINES—**  
**SERVICE CENTERS**  
**LETHBRIDGE**  
**CUSTOM ENGINE & PARTS LIMITED**  
 316 34 St S-----Lethbridge 328-8181  
**PICTURE BUTTE**  
**BUTTE MOTORS & FARM SUPPLY LTD**  
 320 Highway Av N-----Picture Butte 732-4406

**Engines—Natural Gas**

**WAYNE'S OILFIELD MAINTENANCE**-----Taber 223-3933

**Engines—Rebuilding & Repairing**

**A Y Core Supply** 219 11 St-----Nobleford 824-3062

**ANGO ELECTRIC LTD**  
 WARRANTY PARTS & SERVICE  
 KAWASAKI - CONTINENTAL  
 FAX 243-1825  
 528 Cleveland Cr SE-----Calgary 287-0422

**Claresholm Auto Tech**  
 4030 3 St E-----Claresholm 625-4162

**Claresholm Power Products**  
 427 43 Av E-----Claresholm 625-3090  
*(See Our Display Advertisement)*

**Custom Engine & Parts Limited**  
 316 34 St S-----Lethbridge 328-8181  
*(See Our Display Advertisement)*

**Cy-Mo Enterprises**  
 3516 24 Av S-----Lethbridge 328-3008

**ELIOS' AUTO SERVICE**  
 2531 4 Av N-----Lethbridge 320-2945

**ENGINE REBUILDERS LTD**  
 Authorized Ford Remanufacturer  
 Contact Your Local Ford Or Mercury Dealer  
 FAX 451-1348  
 14710 112 Av-----Edmonton 455-4131

FIND IT HERE FIRST

**Engines—Rebuilding & Repairing (Cont'd)**

**Head Masters** 2640 2 Av N---Lethbridge 380-2438  
*(See Our Display Advertisement)*

**Les's Auto Clinic**  
 33205 6 Av N-----Lethbridge 381-9583

**Lethbridge Truck & Auto Maintenance (1992) Ltd** 1 3205 8 Av N---Lethbridge 320-2545

**Morrison Auto - Industrial Machine**  
 Rear 5207 47 Av-----Taber 223-8399  
*(See Our Display Advertisement)*

**Niels & Gord's Lawn Mower & Small Engine Repair**  
 3266 10 St N-----Lethbridge 328-9178

**SILVER AUTOMOTIVE (LETH) LTD**  
 ENGINE REBUILDING & MACHINE WORK  
 CYLINDER HEAD RECONDITIONING  
 3042 2 Av N-----Lethbridge 328-9621



**CEP**  
**CUSTOM ENGINE & PARTS LIMITED**  
 Complete Automotive Machine Shop & Parts Department  
 ENGINE INSTALLATION AVAILABLE  
**328-8181**  
 Call Toll Free 1-800-661-8006  
 FAX 329-6142  
 316 - 34th ST. S., LETHBRIDGE

**Engines—Rebuilding & Repairing (Cont'd)**

**Trev's Automotive Machine Ltd**  
 3604d 9 Av N-----Lethbridge 327-2079  
*(See Our Display Advertisement)*

**WALLY'S IRRIGATION SERVICES (1985) LIMITED**  
 REPAIRS ON ALL MAKES & MODELS  
 • ISUZU • LOMBARDINI • KOHLER  
 • BRIGGS & STRATTON  
 PARTS - SALES - SERVICE  
 MOBILE SERVICE  
 FAX LINE 328-5321  
 4314 1st Av S-----Lethbridge 328-9382

**Westside Service Ltd**  
 Automotive & Agricultural Repairs  
 Milk River 647-2276  
 Fax Line-----Milk River 647-3668



**TREV'S AUTOMOTIVE MACHINE LTD.**  
 COMPLETE ENGINE REBUILDING & AUTOMOTIVE MACHINE SHOP SERVICE  
  
**327-2079**  
 3604D - 9th AVE. N., LETHBRIDGE

**Engravers' Equipment & Supplies**

**GRAV-TECH CANADA INC**  
 ENGRAVING EQUIPMENT & SUPPLIES  
 LASER ENGRAVING • WALNUT PLAQUES  
 PLASTIC CUTTERS • SIGN HOLDERS  
 (No Charge Dial) -----1-800-661-1278

**NEW HERMES LTD**  
 Industry Leader In Computerized And Manual Engraving Machines & Material  
 No Charge Dial-----1-800-387-3130  
 Western Reg Showroom Bby --1-604-294-6066

**Engravers—General**

**B & K SPORT TROPHIES**  
 TROPHIES, MEDALLIONS, PLAQUES  
 ENGRAVING SERVICE  
 921 22 Av-----Coaldale 345-2211

**Higa's Jewellery Ltd**  
 406 13 St N-----Lethbridge 327-7610

**MIDNIGHT NEWS & NOVELTY**  
 260 24 St-----Fort Macleod 553-4046

**Royal Rubber Stamp Co Ltd**  
 Edmonton (No Charge Dial)-----1-800-272-8859

**Things Remembered Div Of National Key**  
 Park Place Mall-----Lethbridge 327-7922

**TRIDENT KEY MART**  
 TROPHIES — PLAQUES — MEDALS  
 PLASTIC SIGNS & NAME BADGES  
 LETHBRIDGE CENTRE MALL  
 245 200 4 Av S-----Lethbridge 320-1530

**TROPHIES UNLIMITED**  
 • EXECUTIVE & CORPORATE AWARDS  
 • PHOTO IMAGING-ADVERTISING SPECIALTIES  
 • FAX LINE 328-0890  
 303 5 St S-----Lethbridge 328-0882

**CREATIVE ADVERTISING MAKES PEOPLE WANT TO BUY -**

**"YELLOW PAGES" TELL THEM WHERE TO BUY.**

**Entertainment & Entertainment Bureaus**

**A Couple Of Real Clowns** -----Calgary 282-0361  
**BE YOUR OWN D J**-----Lethbridge 320-0786

**ENTERTAINMENT EXPERIENCE**  
 Get the music people Recommend  
 Weddings Business Social & Club Parties  
 -----Lethbridge 320-9945

**Fawnsy's Entertainment**  
 514n Broadway-----Raymond 752-4877

**FEEDBACK**  
 LIVE DANCE BAND  
 WEDDINGS & SPECIAL OCCASIONS  
 Call LETHBRIDGE Res: 329-9282, Or  
 -----Taber 223-4337

**Flying Spur Saloon**  
 1016 1 Av S-----Lethbridge 320-6006

**GREAT CANADIAN BARN DANCE**  
 Entertainment For All Occasions  
 Company Parties/Retreats/Family Reunions  
 RV Camping & Cottage Accommodations  
 Box 163 Hilspring -----GLWD 626-3407

**Karaoke T J**-----Lethbridge 329-3470  
**Lethbridge Bingo Centre S A B A**  
 2920 18 Av N-----Lethbridge 320-9938

**OBSSESSIONS ESCORTS**  
 ADULT ENTERTAINMENT  
 STAGS / STAGETTES / PRIVATE PARTIES  
 -----Lethbridge 381-2088

**PYRAMID ENTERTAINMENT D J SERVICE**  
 Your First Choice Mobile DJ Service  
 See Our Ad Under Disc Jockeys  
 -----Lethbridge 320-0712

**Roadshow Music Services**-----Lethbridge 381-0557  
**Silk 'N Roses**-----Lethbridge 327-6953  
**Sounds Unlimited Inc**  
 Mobile Disc Jockey Service-----Lethbridge 320-5956

**STARDUST**  
 Whether It Be Country, Rock & Roll  
 Or The Classics • Book Now •  
 Versatile Live Entertainer Karen Graham  
 -----Coutts 344-2162

**Environmental Conservation & Ecological Organizations**

**Environment Resource Centre**  
 535 13 St N-----Lethbridge 328-5774

**Environmental Products & Services**

**Action On Waste** Call Toll Free---1-800-463-6388  
**CANADIAN CHALLENGER ASSOCIATES LTD**  
 Ofc 451 M Magrath Dr S Sandman Plaza  
 Box 1561-----Lethbridge 320-8161  
 Fax Line-----Lethbridge 320-8163

**CHILAKO DRILLING SERVICES**  
 ENVIRONMENTAL DRILLING  
 SOIL & GROUNDWATER REMEDIATION  
 MONITORING WELL INSTALLATIONS  
 1432 11 St-----Coaldale 345-3710

**Contract Pedology Services Ltd**  
 550 Belfast St SE-----Medicine Hat 529-6660  
**Cox G W Construction Ltd**  
 1210 31 St N-----Lethbridge 328-1346

**D B S ENVIRONMENTAL**  
 See Our Display Ad Under  
 Waste Disposal Industrial Hazardous  
 Fax 328-4729  
 1425 33 St N-----Lethbridge 328-4833

**DOUBLE D DRILLING**  
 GEOTECHNICAL/ENVIRONMENTAL DRILLING  
 -----Lethbridge 320-2144

(CONTINUED NEXT LISTING PAGE)

**CAN'T RECALL A NAME?  
 LOOK IN THE "YELLOW PAGES"  
 THEY WILL HELP YOU.**



**HEAD MASTERS**  
 DIVISION OF HUB IRRIGATION SERVICES LTD.  
 ★ COMPLETE CYLINDER HEAD RE-MANUFACTURING, ENGINE BUILDING & ASSOCIATED PARTS  
 ★ DISTRIBUTOR RE-CURVING  
 ★ SPECIALIZING IN PROPANE, NATURAL GAS & ALUMINUM CYLINDER HEADS  
 ★ PERFORMANCE ENGINES, MODIFICATIONS & PARTS  
**380-2438**  
 2640 - 2nd Ave. N., LETHBRIDGE

**CLARESHOLM POWER PRODUCTS**



- KAWASAKI
- BRIGGS & STRATTON
- KOHLER • TECUMSEH
- JONSERED SAWS
- WISCONSIN

• REPAIRS TO ALL TYPES MAX 20 HP GAS ENGINES

**625-3090**  
 427 - 43rd AVE. EAST  
 CLARESHOLM, AB T0L 0T0

**MORRISON**

**AUTO-INDUSTRIAL MACHINE**

- ALL TYPES OF ENGINE REBUILDING
- FLYWHEEL, DRUM & ROTOR MACHINING
- RE-BORING
- PRESSURE TESTING
- MAGNIFLUXING



**223-8399**  
 AFTER HOURS 223-8286  
 REAR 5207 - 47th AVENUE  
 BOX 1362, TABER, ALBERTA T0K 2G0

**Environmental Products & Services (Cont'd)**

**DUFF'S BULK SERVICE LTD**  
Industrial & Environmental  
Vacuum Service  
Fax 328-4729  
1425 33 St N -----Lethbridge **328-4833**

**ENVIRONMENTAL LAW CENTRE (ALBERTA) SOCIETY**  
Edmonton (No Charge Dial) ----- **1-800-661-4238**  
**GEOWEST ENVIRONMENTAL CONSULTANTS LTD** -----Edmonton **461-5000**  
**H B T AGRA LIMITED**  
1430b 31 St N -----Lethbridge **327-7474**  
Hazmacon Environmental Services Inc  
Edmonton (No Charge Dial) ----- **1-800-563-7441**  
**HI-COUNTRY ENVIRONMENTAL SERVICES LTD**  
Box 73 -----Pincher Creek **627-5429**  
**MID-WEST PUMP (90) LTD**  
311 33 St N -----Lethbridge **329-0427**  
**Ovine Enviro Systems Inc**  
Box 427 -----Taber **223-9418**

**Escort Service**

**A' Plus Heavenly Angels Escorts** -----Lethbridge **320-5683**  
(See Our Display Advertisement)  
**Classic Connection** -----Lethbridge **327-9911**  
**Obsessions Escorts** -----Lethbridge **381-2088**  
(See Our Display Advertisement)  
**Over Thirty Escorts** -----Lethbridge **380-6011**

Your telephone will become one of your star sales representatives if you will extend your sales territory by advertising in the **YELLOW PAGES**.

**Escort Service (Cont'd)**

**Paradise Escorts** -----Lethbridge **381-0204**  
(See Our Display Advertisement)  
**Silk 'N Roses** -----Lethbridge **327-6953**  
(See Our Display Advertisement)  
**Sweet Chic Escorts** -----Lethbridge **380-4929**  
(See Our Display Advertisement)  
**Tantalizing Moments Escorts** -----Lethbridge **380-3110**  
**Whispers Escort** -----Lethbridge **327-9093**

Remember, to the caller there is no such thing as an unimportant telephone call. Otherwise, he wouldn't have taken the time and trouble to call you in the first place.

**Estate Consultants**

**Paterson Dimnick**  
1412 3 Av S -----Lethbridge **320-9800**

**Estate Planning Consultants**

**Gray Insurance Planning**  
2210 26 A St S -----Lethbridge **328-6557**

**FIND WHAT YOU WANT — WHEN YOU WANT IT — PRODUCTS — DEALERS — SERVICES — PROFESSIONS** are listed . . . by classification. . . throughout these pages. You can find almost anything you need quickly and easily when you use **THE YELLOW PAGES**.

**Excavating Contractors (Cont'd)**

**BLAIR EXCAVATING LTD**  
580 CASE BACKHOE  
TRENCHING FOR WATER & SEWER  
OWNER OPERATED  
2006 20 St N -----Lethbridge **327-4058**

**Bob's Septic Tank Services** -----Coakdale **345-3528**  
(See Our Display Advertisement)

**Bosch Excavating Ltd**  
Box 193 Monarch -----Fort Macleod **553-2055**  
(See Our Display Advertisement)

**BOYCE DON CONTRACTING**  
Lundbreck -----Cowley **628-3978**  
**Brian's Excavating & Hauling Ltd**  
6101 22 Av Coleman -----Crownsnest Pass **563-3014**  
(See Our Display Advertisement)

(CONTINUED NEXT LISTING PAGE)

**Obsessions**  
ESCORTS  
ADULT ENTERTAINMENT  
**381-2088**

**ACE BOBCAT SERVICE**

- TOP SOIL
- DRIVEWAYS
- POST HOLES
- SNOW REMOVAL
- GENERAL CLEAN-UP
- LANDSCAPING
- STUMP REMOVAL
- GENERAL TRUCKING
- PARKING LOT SWEEPING

**327-9711**  
LETHBRIDGE

**A' PLUS**  
HEAVENLY ANGELS ESCORTS  
**320-5683**  
LETHBRIDGE

**Paradise Escorts**  
For A Trip To Paradise  
Call  
**381-0204**  
Lethbridge

**ALDOFF DRAGLINE SERVICES**  
OWNER/OPERATOR  
— 1 YARD BUCKET WITH 55 FT. BOOM  
— WET OR DRY EXCAVATING  
— NEW DUG OUT & CLEAN OUT  
— CANAL & DRAIN DEMOLITION  
— ALSO OFFER PORTABLE WELDING SERVICE  
**320-7299**  
RR8 - 38 - 6 LETHBRIDGE

**SILK 'N ROSES**  
SILK 'N ROSES  
PROFESSIONAL MASSEUSE & REFLEXOLOGISTS  
**327-6953**  
LETHBRIDGE

**Sweet Chic Escorts**  
**380-4929**  
LETHBRIDGE  
11 A.M. - 2:30 A.M.

**Excavating Contractors**

**Accent Landscaping** -----Lethbridge **328-0919**  
**Ace Bobcat Service** -----Lethbridge **327-9711**  
(See Our Display Advertisement)  
**Aldoff Dragline Services**  
RR 8 38 6 -----Lethbridge **320-7299**  
(See Our Display Advertisement)  
**Armco Bobcat & Trucking**  
Box 1664 -----Lethbridge **328-5120**  
(See Our Display Advertisement)  
**B & J EXCAVATING & BACKHOE SERVICE**  
BACKHOE SERVICES  
Box 36 -----Vauxhall **654-2463**  
**Benny's Construction**  
7 Kings Cr S -----Lethbridge **320-9141**  
**Big D Enterprises Ltd**  
97 Greenview Close N -----Lethbridge **320-2634**  
(See Our Display Advertisement)

**ARMCO BOBCAT & TRUCKING**  
GENERAL BOBCAT WORK & HAULING  
24 HOUR SERVICE  
**328-5120**  
BOX 1664, LETHBRIDGE

# BIG D ENTERPRISES LTD.



Excavation  
Demolition  
Snow Removal  
Screened Top Soil  
**David Wipf**

**320-2634**

CELLULAR - 380-9025 FAX - 328-4042  
97 GREENVIEW CLOSE N., LETHBRIDGE

# BRIAN'S EXCAVATING & HAULING LTD.

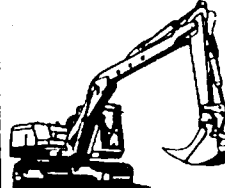

• ALL YOUR BACKHOE NEEDS

**563-3014**

6101 - 22nd AVENUE, COLEMAN CROWSNEST PASS

## Excavating Contractors (Cont)

- Burns Excavating ----- Stavelly 549-3946
- C G Excavating 1110 9 St N - Lethbridge 320-1857  
(See Our Display Advertisement)
- C & R Bobcat & Concrete Service ----- Lethbridge 381-4462  
(See Our Display Advertisement)
- C & V Excavating ----- Lethbridge 327-3555  
Box 1484 ----- Lethbridge 327-3555  
(See Our Display Advertisement)
- Cam-Way Bobcat & Trucking ----- Lethbridge 329-4568
- Coaldale Backhoe Service ----- Coaldale 345-2449  
1510 18 Av ----- Coaldale 345-2449  
(See Our Display Advertisement)
- Compleas Limited ----- Lethbridge 381-7133  
18 Laurentian Place W ----- Lethbridge 381-7133  
Fax Line ----- Lethbridge 381-7133  
Long Distance Charge May Apply ----- 1-554-5222  
Long Distance Charge May Apply ----- 1-554-5222  
Long Distance Charge May Apply ----- 1-554-5222
- Coron Backhoe Service ----- Taber 223-9193  
5618 51 St ----- Taber 223-9193  
(See Our Display Advertisement)
- Cox G W Construction Ltd ----- Lethbridge 328-1346  
1210 31 St N ----- Lethbridge 328-1346  
Fax Line ----- Lethbridge 328-0359  
(See Our Display Advertisement)
- CUSTOM BOBCAT & TRUCKING** ----- Lethbridge 329-0983  
(See Our Display Advertisement)
- D C Construction Ltd ----- Lethbridge 381-4854  
Box 484 Coalhurst ----- Lethbridge 381-4854
- D & C Digging Backhoe Service ----- Fort Macleod 553-3177  
Box 1957 ----- Fort Macleod 553-3177
- D & M Trenching Box 67 ----- Granum 687-2232
- de Graaf Excavating Ltd ----- Lethbridge 320-5647  
2215 41 St N ----- Lethbridge 320-5647
- Del Bonita General Store ----- Magrath 758-6444
- Dennis L W Contracting Ltd ----- Lethbridge 327-9678  
5511-3-75 ----- Lethbridge 327-9678
- Dirty Deeds Done ----- Lethbridge 381-6559  
(See Our Display Advertisement)

# BOB'S SEPTIC TANK SERVICES



**345-3528**

COALDALE  
IF NO ANSWER CALL

**380-0185**

CELLULAR  
• CLEANING

THE LIL' HONEY WAGON

**WE INSTALL SEPTIC TANKS & CISTERNS**

# C. G. EXCAVATING BACKHOE - BOBCAT & TRUCKING

- BASEMENTS
- TRENCHING
- TOP SOIL
- POST HOLES
- WATER & SEWER
- DEMOLITION
- DRIVEWAYS
- SAND & GRAVEL
- SNOW REMOVAL

**320-1857**

1110 - 9th STREET N. LETHBRIDGE

(CONTINUED NEXT LISTING PAGE)

# Bosch Excavating Ltd.

Serving Southern Alberta

- General Contracting
- Demolition
- Concrete Breaking /Removal
- Basements
- Backfilling & Compaction
- Water Lines /Trenching
- Sewer Lines
- Drain Tiles
- Irrigation Mainline /Trenching
- P.V.C. Sales /Installation
- Trucking
- Snow Removal

"Quality Work At Fair Prices"

LETHBRIDGE

**320-1113**

Shop / Fax  
FORT MACLEOD

**553-2055**

Mobile 1-581-8602

Box 193, Monarch  
TOL OZO

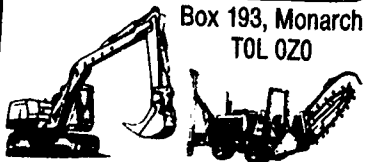

# BOBCAT AND CONCRETE SERVICE

Established 1973  
**CLIFF DUDLEY SR. 381-4462**

LETHBRIDGE  
DIVISION OF SUNSET CITY BOBCAT SERVICE

QUALITY WORKMANSHIP  
FREE ESTIMATES  
GENERAL TRUCKING

- LANDSCAPING & LAWN MAINTENANCE
- POSTHOLES
- GARAGE BUILDING
- SIDEWALKS
- DRIVEWAYS
- FENCES
- PATIOS (Wood & Concrete)
- SNOW REMOVAL
- CORRAL CLEANING & BUILDING

# G & V EXCAVATING & HAULING

- BASEMENTS
- BACKHOE SERVICES
- TRUCKING
- TRENCHING
- DEMOLITION
- SEPTIC TANKS
- SAND, GRAVEL, TOP SOIL
- WATER
- SEWER
- SNOW REMOVAL
- BOBCAT SERVICE/POST HOLES

**327-3555**

BOX 1484, T1J 4K2



Serving Lethbridge & Area

# COALDALE BACKHOE SERVICE

SERVING COALDALE & SOUTHERN ALBERTA

- 1', 2' & 3' TRENCHING
- BASEMENTS
- IRRIGATION
- TRUCKING (TARP)
- SAND & GRAVEL
- BACKFILL
- SNOW REMOVAL

"WE DIG YOU" OWNER: JOHN VINK

— 24 HOURS —

**345-2449**

CELLULAR: 380-0773

1510 - 10th AVE., COALDALE T1M 1K7

# BACKHOE SERVICE BY CORON

TRENCHING  
GENERAL EXCAVATING  
FRONT LOADER WORK  
RESIDENTIAL — COMMERCIAL

24 HOUR SERVICE  
CORON BACKHOE SERVICE

OWNED & OPERATED  
BY RON ABELL

**223-9193**

5618 - 51st STREET  
TABER

## CUSTOM BOBCAT & TRUCKING

- ★ CONCRETE WORK
- ★ YARD CLEAN-UP
- ★ SNOW REMOVAL
- ★ FENCE BUILDING
- ★ LANDSCAPING
- ★ POST HOLES
- ★ DEMOLITION
- ★ DRIVEWAYS
- ★ BACKHOE
- ★ TURFING



**329-8983**

LETHBRIDGE

## DIRTY DEEDS DONE

Trucking & Excavation

REMOVAL OR DELIVERY OF ANY MATERIAL

- ★ LANDSCAPING ★ TOPSOIL
- ★ GRAVEL ★ POST HOLES
- ★ DEMOLITION & SNOW REMOVAL

**381-6550**

LETHBRIDGE

HOURLY OR CONTRACT



# G. W. COX CONSTRUCTION LTD.

## EXCAVATING SPECIALISTS

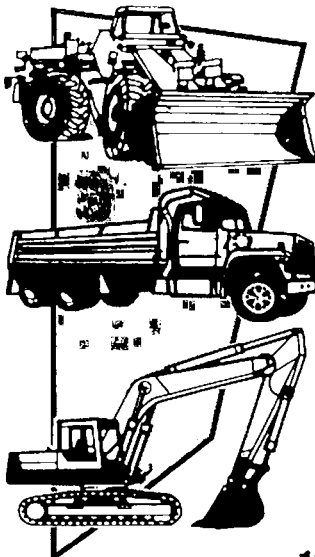

- SEWER & WATER
- INDUSTRIAL SITE DEVELOPMENT
- OILFIELD & IRRIGATION CONTRACTING
- HEAVY EQUIPMENT RENTALS (HOURLY)
- DUGOUTS • RIP RAP • DEMOLITION
- GRADALL TYPE WORK
- BOBCAT & POSTHOLE SERVICE
- SNOW REMOVAL
- SAND & GRAVEL • TOP SOIL
- ENVIRONMENTAL SERVICES
- HEAVY HAULING
- LASER SURVEYING
- ROAD BUILDING
- GENERAL CONTRACTOR

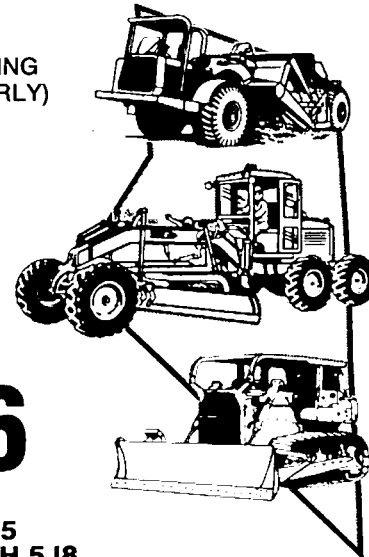

**328-1346**

FAX LINE 328-0350

DARRELL CELLULAR 380-1045

1210 - 31st ST. N., Lethbridge T1H 5J8

## DOUBLE G BOBCAT & TRUCKING

- EXCAVATING
- POST HOLES
- GENERAL HAULING
- TOPSOIL
- CONCRETE REMOVAL
- SAND & GRAVEL
- SNOW REMOVAL
- DRIVEWAYS

24 HOUR SERVICE

**345-5452**

380-0345

CELLULAR

1906 - 22nd AVE., COALDALE



## DUECK EQUIPMENT SALES

- |                     |              |
|---------------------|--------------|
| GENERAL CONTRACTING |              |
| SAND & GRAVEL       | SNOW REMOVAL |
| WATER & SEWER       | IRRIGATION   |
| CONCRETE BREAKING   | GRADALL WORK |
| TOP SOIL            | RIP RAP      |
| DEMOLITION          | PARKING LOTS |

24 HOUR ANSWERING

**328-7692**

FAX - 328-4042

4400 - 9th AVENUE N., LETHBRIDGE

# DRACO

## EXCAVATING

"WE DIG YOU THE MOST"

- TRENCHING — EXCAVATING — BACKFILLING  
HAULING — DEMOLITION — SNOW REMOVAL  
— BASEMENT EXCAVATION — TOPSOIL

SHOP:

24 HOUR ANSWERING SERVICE

1525 - 33rd Street North  
LETHBRIDGE T1H 5H2

**327-6606**

## EARL'S CONSTRUCTION LTD.



Complete line of  
Earthmoving Equipment  
Hourly or Contract

Serving Lethbridge & Area Since 1975

**328-3622**

LETHBRIDGE



# GETKATE CONSTRUCTION (1976) LTD.

- General Contractors
- Commercial, Industrial, & Heavy Civil
- Heavy Equipment Rentals
- Crane Rentals
- Sewer & Water
- Dewatering - Wellpoint Systems
- Demolition
- Pipelines

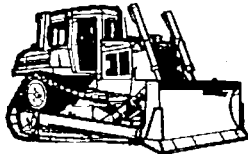
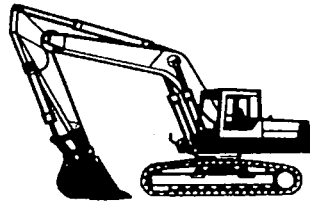

**327-7542**

FAX 327-3354

Office & Plant - Sunnyside Dist.  
RR8-34-B  
Lethbridge, T1J 4P4

LETH. CELLULAR (CHARGE MAY APPLY)  
1-551-8445 • 1-554-9922

### Excavating Contractors (Cont'd)

- Double G Bobcat & Trucking  
1906 22 Av -----Coaldale 345-5452  
(See Our Display Advertisement)
- DRACO EXCAVATING  
1525 33 St N -----Lethbridge 327-6606  
(See Our Display Advertisement)
- Dueck Equipment Sales  
4400 9 Av N -----Lethbridge 328-7692  
(See Our Display Advertisement)
- EARL'S CONSTRUCTION LTD  
-----Lethbridge 328-3622  
(See Our Display Advertisement)
- Ed Wiebe Contracting  
Box 1386 Pincher Creek -----Cowley 628-3614  
(See Our Display Advertisement)
- El Ge Construction Ltd  
Box 2521 -----Pincher Creek 627-3297  
(See Our Display Advertisement)
- Elenor Enterprises Ltd  
Box 1896 -----Lethbridge 327-7370  
(See Our Display Advertisement)

### Excavating Contractors

- Emard Excavating Ltd  
Box 1012 -----Lethbridge 381-3121  
(See Our Display Advertisement)
- ERDMAN EXCAVATING  
DRAGLINE HY-HOE D6 DOZER  
LO-BOY PAYLOADER, SAND & GRAVEL  
AFTER HOURS RES 687-2163  
-----Lethbridge 382-1020
- 5 S ENTERPRISES LTD  
Box 130 -----Cowley 628-3912

(CONTINUED NEXT LISTING PAGE)

Hunting for a reliable firm? You will find hundreds of them right here in the YELLOW PAGES.

## EMARD EXCAVATING LTD.

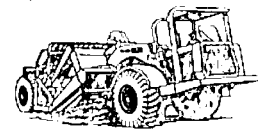

**WE MOVE THE EARTH**  
FULL LINE OF EARTHMOVING EQUIPMENT

**381-3121**

FAX LINE 381-3156

BOX 1012, LETHBRIDGE

## edge<sup>®</sup> CONSTRUCTION LTD.

- GENERAL EXCAVATION
- TRUCKING
- DUGOUTS
- TRACK HOE SERVICE
- DEMOLITION
- SNOW REMOVAL

FREE ESTIMATES

**627-3297**

MOBILE: 1-382-0300  
FAX LINE: 627-4786  
(No Charge Dial) 1-800-363-0330

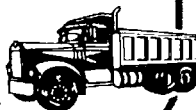
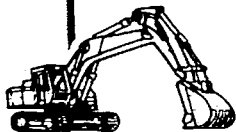

Laverne Toews, Box 2521, Pincher Creek, AB T0K 1W0



## GT EXCAVATING LTD. OWNER — GEORGE DE GRAAF

- DITCHING
- DUG OUTS
- EARTHMOVING
- GRADALL TYPE WORK
- ALL TYPES OF EXCAVATING RURAL AND RESIDENTIAL

**PHONE 381-4600**

P.O. BOX 1570, LETHBRIDGE, AB T1J 4K3

## ELENOR ENTERPRISES LTD.

Main Office **327-7370**

Shop 327-5453  
FAX 327-7524

Long Distance Charges May Apply:

- Complete Oil Field Service
- Heavy Equipment Rentals
- Heavy Equipment Hauling
- Bulldozers, Motor Scrapers, Road Graders, Winch Tractors
- Low Beds, Ripper Cats and Tow Cats, etc.

- Mike Stringer 1-554-5469
- Claus Madsen 1-554-6534
- Gord Blair 382-1369
- Ken Brodoway 1-557-7268
- Paul Sincennes 1-557-8332
- Mel Kast 1-557-7086
- Truck Foreman 1-557-7087

Box 1896, Lethbridge,  
T1J 4K5

## Ed Wiebe Contracting

ROAD BUILDING & EXCAVATING

**628-3614**

COWLEY

IF BUSY CALL  
PINCHER CREEK **627-2839**

Long Distance (Charge May Apply)  
1-551-7277



Box 1386  
Pincher Creek

## GARRETT EXCAVATING & TRUCKING

OWNER OPERATED

- Excavating
- Basements
- Irrigation Work
- Custom Work
- Trenching
- Red Shale
- Dirt Hauling



LETHBRIDGE  
**381-3773**

BOX 701, COALHURST, ALTA. T0L 0W0

**Excavating Contractors (Cont'd)**

**FLINTSTONE DEMOLITION CONTRACTORS**  
 • DRIVEWAYS • GARAGE PADS & BASEMENTS  
 • POST HOLES • H2O & SEWER REPAIR  
 • FUEL TANKS • SEPTIC FIELDS • GRAVEL  
 • SAND, LOAM SUPPLIED • SPREAD  
 BOBCATS • TRUCKS  
 EXCAVATORS • COMPACTORS  
 COMPETITIVE RATES  
 -----Calgary 279-2500

**FOREMOST CAT SERVICE** -----Foremost 867-2188

**FREDS EXCAVATING**  
 TRENCHING • BASEMENTS • BACKFILLING  
 GRAVEL HAULING  
 18 YEARS IN BUSINESS  
 173 N & 1 St E -----Macgrath 758-3569

**G T Excavating Ltd**  
 Box 1570 -----Lethbridge 381-4600  
 (See Our Display Advertisement)

**Garrett Excavating & Trucking**  
 Box 701 Coalhurst -----Lethbridge 381-3773  
 (See Our Display Advertisement)

**Getkate Construction (1976) Ltd**  
 RR 8-34-8 -----Lethbridge 327-7542  
 (See Our Display Advertisement)

**Gunnlaugson Gradall Services**  
 -----Lethbridge 329-9292  
 (See Our Display Advertisement)

**Gustum Excavating Ltd**  
 2706 7a Av N -----Lethbridge 327-5251  
 (See Our Display Advertisement)

**H & H DRILLING**  
 BACKHOE WORK  
 TRENCHING & PUMP SERVICE  
 Charge May Apply 1-551-7704  
 Box 1686 -----Fort Macleod 553-2365

**H L Excavating 3 A Hwy N** -----Lethbridge 381-6711  
 1712 23 St -----Coaldale 345-2807  
 (See Our Display Advertisement)

**HANSEN'S EXCAVATING & TRUCKING LTD**  
 5310 46 St -----Taber 223-9162

**Hirsche Backhoe Service**  
 Box 87 -----Stirling 756-3961

**HOLHOE CONTRACTORS LTD**  
 -----Lethbridge 329-0223  
 (See Our Display Advertisement)

**J & I HOLDINGS LTD**  
 Earth Moving Cat Scraper Grading  
 Front End Loader, Sand & Gravel  
 Box 302 -----Milk River 647-3923

**J R TRENCHING**  
 6007 54 Av -----Taber 223-4933

**Ken's Loader Service**  
 Long Distance Charge May Apply -----1-551-7195  
 (See Our Display Advertisement)

**Knibb Developments Ltd**  
 5802 60 Av -----Taber 223-8984  
 Fax Line -----Taber 223-3476

**L A PAVING LTD**  
 Box 2204 -----Lethbridge 329-1381

(CONTINUED NEXT LISTING PAGE)

Get The Yellow Pages Habit

**HL**   
 EXCAVATING  
 ■ BACKHOE WORK  
 ■ MAIN LINE TRENCHING  
 ■ TRENCHING FOR ELECTRICAL  
 ■ LASER EQUIPMENT  
 LETHBRIDGE ----- COALDALE  
**381-6711 345-2807**  
 3A HWY. N. ----- 1712 - 23rd ST.  
**382-0373**  
 CELLULAR

**HOLHOE CONTRACTORS LTD.**  
 ● TRENCHING  
 ● BACKHOE WORK  
 ● SEWER SYSTEMS  
 ● CABLE PLOWING  
 ● ROAD BORING  
**329-0223**  
 TONY VANDEN HOEK  
 MAILING ADDRESS  
 BOX 1897  
 LETHBRIDGE

**KEN'S LOADER SERVICE**  
 ★ BOBCAT SERVICE  
 ★ POST HOLES  
 ★ GRAVEL TOPSOIL  
 ★ GENERAL TRUCKING  
 KEN JAGERSMA, RES. COALDALE 345-3740  
**1-551-7195**  
 LONG DISTANCE  
 CHARGE MAY  
 APPLY

**MILLER F. EXCAVATING LTD.**  
 ALL TYPES OF  
 ● HY-HOE  
 ● GRADER  
 ● CAT WORK  
  
 FRANK RES. 654-2266  
 BOB RES. 654-2536  
 GORD RES. 654-4115  
**654-2064**  
 127 - 1st AVENUE N., VAUXHALL

**GUNNLAUGSON**   
 GRADALL SERVICES  
 CONTRACTING & RENTAL  
 ● IRRIGATION & DRAINAGE DITCHING  
 ● EARTHMOVING  
**329-9292**  
 FAX  
 329-9278  
 MAILING ADDRESS: BOX SS1-3-177, LETHBRIDGE T1J 4B3

**GUSTUM EXCAVATING LTD.**  
 ● Dragline Service  
 ● ¾ Yard & 1¼ Yard Buckets  
 ● 65 Feet of Boom  
 ● Dragline Ditching & Dugouts  
**327-5251**  
 2706 - 7A Ave. N., Lethbridge

**MENNIVEN EXCAVATING LTD.**  
 General Contractors  
 ★ Draglines  
 ★ Hy Hoes  
 ★ Grader & Dozer  
 ★ Earth Moving  
 AFTER HRS. CALL RES.  
 654-2815 or 654-2049  
**654-2440**  
 SHOP: 654-2585  
 929 - 3rd Ave. N., Vauxhall

**MIKE RETTIE EXCAVATING**  
 (DIVISION OF 522 187 ALBERTA LIMITED)  
 ● BACKHOE, GRADALL & TRAK-HOE SERVICE  
 ● OILFIELD WORK  
 ● FEED LOT WATERING  
 ● GRADALL WORK, DITCH & DRAINAGE MAINTENANCE  
 ● BASEMENT EXCAVATION  
 ● WATER & SEWER INSTALLATION & REPAIR  
 ● DEMOLITION & TRUCKING  
 ● ASPHALT & CURB REMOVAL  
 ● IRRIGATION WORK  
 SERVICING CITY & RURAL AREA  
**382-0173**  
 LETHBRIDGE CELLULAR  
 CALL MIKE RES 732-5002  
 BOYD RES 732-4593  
 PICTURE BUTTE

**Quality Bobcat & Trucking Service**  
a division of 389808 Alta. Ltd.



**Serving Lethbridge & Area Since 1985**

- GRADING
- FENCING
- CORRAL CLEAN-UPS
- CERTIFIED CARPENTER FOR ALL TYPES OF CONTRACTING
- CONCRETE REMOVAL & PLACEMENT
- GENERAL TRUCKING
- SNOW REMOVAL
- 24 HOUR SERVICE

**382-7674**

IF BUSY CALL 381-2728  
P.O. BOX 1662, LETHBRIDGE

**Southern Backhoe Ltd.**

**OWNER OPERATED**

- EXCAVATING
- BASEMENTS
- TOPSOIL & MANURE
- CUSTOM WORK
- SAND & GRAVEL
- BACKFILL
- FENCING

"Serving Southern Alberta"

**345-2596**

BOX 708, COALDALE

**Excavating Contractors (Cont.)**

**M P CRUSHING LTD**  
SAND & GRAVEL SUPPLY  
FAX 381-3414  
Box 3 Kipp ----- Lethbridge 381-3744

**MCLAREN BOBCAT SERVICE**  
34 Oriole Rd N ----- Lethbridge 327-3762

**McLellan Fencing**  
2345 2a Av N ----- Lethbridge 329-0625

**McNiven Excavating Ltd**  
929 3 Av N ----- Vauxhall 654-2440  
Shop ----- Vauxhall 654-2585  
(See Our Display Advertisement)

**Mensinger Contracting** ----- Lomond 792-3922

**Mike Rettie Excavating** ----- Lethbridge 382-0173  
(See Our Display Advertisement)

**Miller F Excavating Ltd**  
127 1 Av N ----- Vauxhall 654-2064  
(See Our Display Advertisement)

**Miller George Sand & Gravel**  
Box 1292 ----- Taber 223-9545  
(See Our Display Advertisement)

**Miller R M's Backhoe & Truck Service**  
Johnson Addition ----- Taber 223-1888

**Neu-Lite Electric Inc** ----- Lethbridge 327-7711

**O'Sullivan Reg Construction Ltd**  
144 13 St ----- Fort Macleod 553-3495

**PINETREE EQUIPMENT RENTALS A DIVISION OF PINETREE SUPPLY LTD**  
255 31 St N ----- Lethbridge 327-2520

**PRAIRIE DITCHING LTD**  
WE FLOW IN  
FARM TILE DRAINAGE & WATER LINES  
QUOTES - SUPPLIES - INSTALLATIONS  
418 26 St S ----- Lethbridge 327-8280

**SERVING LETHBRIDGE & SOUTHERN ALBERTA**

**SUNSHINE EXCAVATING LTD.**

OWNER OPERATED GORDON CARD

**INDUSTRIAL, COMMERCIAL & RESIDENTIAL**

- BASEMENTS
- TRUCKING
- SAND & GRAVEL
- LOADERS 1 - 3 YDS.
- OILFIELD SERVICES
- POST HOLES
- SEPTIC TANKS & FIELDS
- HYDRAULIC CONCRETE BREAKING
- ROAD BORING
- TRENCHING
- IRRIGATION & DRAINAGE WORK

**MAGRATH 758-3195 ALBERTA**

**Larry Stevenson**  
Excavating Ltd.

**BASEMENTS • TRENCHING**  
**WATER & SEWER LINES**  
(LIC. #921)  
**PIPE PUSHING**

**320-0212**

CELLULAR 382-5800  
1306 WATERTON RD. S.  
LETHBRIDGE



**Quality Bobcat & Trucking Service**  
Box 1662 ----- Lethbridge 382-7674  
(See Our Display Advertisement)

**Riviere's Construction Ltd**  
1165 Waterton Av ----- Pincher Creek 627-4131  
(See Our Display Advertisement)

**ROLLING HILLS EXCAVATING LTD**  
CAT & BACKHOE SERVICE

Call Marv ----- Rolling Hills 964-2124  
Call Rick (Res) ----- 964-3503  
Cellular ----- Brooks 362-1972

**MILLER GEORGE SAND & GRAVEL**



- General Excavating
- Grader Work
- Dug Outs
- Sand & Gravel
- Road Building
- Hy-Hoe

**223-9545**

IF NO ANSWER CALL TIM RES. 223-9588  
BOX 1292, TABER

**Rombough D. EARTHMOVING Ltd.**

**GENERAL CONTRACTORS OILFIELD SERVICE EARTHMOVING DUGOUTS**

CAT / HY-HOE / SCRAPERS  
HOURLY OR CONTRACT  
Over 25 Years Experience

RES./OFC./FAX. 654-2381      CELLULAR 382-7242

SHOP 654-2044  
MR. LUTY & VAUXHALL

**TRECHKA EXCAVATING**

- CAT
- DRAGLINE
- HI-HOE
- BACKHOE
- GRAVEL TRUCK
- SCRAPER

**732-4440**

PICTURE BUTTE, ALBERTA

**Rombough D Earthmoving Ltd**  
549 1 Av S ----- Vauxhall 654-2044  
(See Our Display Advertisement)

**Ron's Bobcat Service**  
2622 12 Av N ----- Lethbridge 329-8381  
(See Our Display Advertisement)

**Scheffer Excavating** ----- Lethbridge 327-2969  
Box 295

**SHOCKEY O D CONSTRUCTION LTD**  
- EARTHMOVING -  
- LAND LEVELLING -  
Orval D. Shockey, Residence 223-8524  
2 MI. N. ON 50 ST. L. SIDE OF RD.  
Box 909 ----- Taber 223-2211

**SOROCHAN ENTERPRISES LTD**  
COMMERCIAL CONTRACTING  
SEWER & WATER  
FAX LINE 380-2455  
1310d 33 St N ----- Lethbridge 327-0736

**RIVIERE'S CONSTRUCTION LTD.**

**627-4131**

1185 Waterton Ave., Pincher Creek  
SHOP BOX 88, 627-2442

**DIRT WORK**  
BACKFILLING — GRADING  
TRUCKING — SAND & GRAVEL  
TOP SOIL

**NIGHT CALLS:**  
JAMES A. RIVIERE, RES....627-2459  
FLOYD F. RIVIERE, RES. ...627-2344

**RON'S BOBCAT SERVICE**

**EXCAVATING**

- REMOVE OR DELIVER ANY MATERIAL
- CONCRETE - SIDEWALKS, ETC.
- POST HOLES
- SNOW REMOVAL
- LANDSCAPING & TREE REMOVAL
- TOP SOIL & MANURE AVAILABLE

— FREE ESTIMATES —

**329-8381**

2822 - 12th Ave. N., Lethbridge T1H 1B4

**WESTON CONSTRUCTION CO. LTD.**

- CONTRACTORS & BUILDERS
- EXCAVATING & CAT WORK
- DITCH WITCH TRENCHING
- GRADAL WORK

**653-3421**

CELLULAR 382-1501  
316 MAIN ST., CARDSTON

**Southern Backhoe Ltd**  
Box 708 11 St ----- Coaldale 345-2596  
(See Our Display Advertisement)

**SOUTHERN TRENCHING**  
2514 16 Av S ----- Lethbridge 327-2504

**Steve Nagy Sand & Gravel Ltd**  
234 McMaster Blvd W ----- Lethbridge 381-6565

**STEVENSON LARRY EXCAVATING LTD**  
1306 Waterton Rd S ----- Lethbridge 320-0212  
Cellular ----- Lethbridge 382-5800  
(See Our Display Advertisement)

**SUNSET CITY BOBCAT SERVICE** -  
See C & R Bobcat & Concrete Service

**Sunshine Excavating Ltd** ----- Magrath 758-3195  
(See Our Display Advertisement)

(CONTINUED NEXT LISTING PAGE)

Get Action,  
Use "Yellow Pages."

# K-SARK

## GYM EQUIPMENT INC.

"10 YEARS OF QUALITY WORKMANSHIP"  
CUSTOM DESIGNED HOME & MAJOR FITNESS  
CENTRE EQUIPMENT

LARGE OR SMALL WE FIT YOUR NEEDS

- FREE WEIGHTS EQUIPMENT
- GYM LAYOUT
- STACKED WEIGHT EQUIPMENT
- SALES & SERVICE
- COLOUR SELECTION

FRAMED EQUIPMENT WITH A GUARANTEE

### 362-8351

431 - 3a STREET WEST, BROOKS



### Exporters

Lakeshore Forage Ltd  
Box 32-----Lethbridge 327-0076

Polardome Company Import Export  
2 Lakota Cr W-----Lethbridge 381-1905  
Fax Line-----Lethbridge 320-1105

Sarcen Forage Marketing Ltd  
1710b 31 St N-----Lethbridge 327-8777  
Fax Line-----Lethbridge 329-1165

Southern Alberta Cubers Inc  
3119 12 Av N-----Lethbridge 380-2800

Tradewinds Canada Ltd  
Box 32-----Lethbridge 327-0076

### Extermination & Fumigation- Pest Control

Alberta Pest Control Services  
Ltd-----Calgary 277-8272

Big Horn Pest Control Ltd  
1212 6 Av S-----Lethbridge 320-1555  
(See Our Display Advertisement)

(CONTINUED NEXT LISTING PAGE)

Yellow Pages advertising gives you maximum circulation. A directory is delivered to every telephone customer in your area. Talk to us today.

Use outdoor public telephones often. They're brightly lighted and located for your convenience in residential and business districts and along highway entrances to the city.

### Excavating Contractors (Cont'd)

**T A EXCAVATING LTD**  
424 Dieppe Blvd S-----Lethbridge 329-0085  
Cellular-----Lethbridge 382-0460

**T A M Excavating**-----Stavely 549-3816

**Taber Excavating**-----Lethbridge 328-8855

**TOP LINE CONSTRUCTION LTD**  
218-Ojowa Place W-----Lethbridge 320-5201  
Fax Line-----Lethbridge 381-6444

**Trechka Excavating**-----Picture Butte 732-4440  
(See Our Display Advertisement)

**TRI-D ENTERPRISES**  
BOBCAT SERVICE • GRAVEL TOPSOIL  
• GENERAL TRUCKING •  
• SNOW REMOVAL •  
-----Lethbridge 320-9045

**Triple J Contracting Ltd**-----Lethbridge 328-7699  
Call Long Distance (Charge May Apply) & Ask For  
Lethbridge-----Mobile XJ5-0636

**Shop**-----Lethbridge 327-4810

**Trotter Contracting Ltd**-----Fort Macleod 553-3027  
Shop-----Fort Macleod 553-4990

**U P P Consulting Inc**  
Box 235-----Lethbridge 381-4974  
Fax Line-----Lethbridge 381-4602

**Weston Construction Co Ltd**  
316 Main St-----Cardston 653-3421  
(See Our Display Advertisement)

**WIEBE G EXCAVATING LTD**  
TRUCKING - EXCAVATING  
CELLULAR 382-7563  
FAX LINE 655-2291  
24 HOUR SERVICE  
Box 684-----Grassy Lake 655-2254

Use the "Yellow Pages" of the telephone directory to catch the eyes of the man or woman when they are ready to buy.

### Exercising Equipment

**APPLE FITNESS STORE LTD**  
COMMERCIAL & RESIDENTIAL SPECIALISTS  
BIKES - STEPPERS - SKIERS  
TREAD MILLS - HOME GYMS  
10746 124 St-----Edm 452-8877

**GO-MANGO FITNESS EQUIPMENT**  
SPECIALIZING IN  
HOME & INSTITUTIONAL  
FITNESS EQUIPMENT  
1274 3 Av S-----Lethbridge 380-3707

**K-Sark Gym Equipment Inc**  
431 3a St W-----Brooks 362-8351  
(See Our Display Advertisement)

**Western Gym-Sales & Service**  
3773 19 St NE-----Calgary 250-5217

### Exhibitions & Fairs

**Claresholm Agriplex**-----Claresholm 625-2410  
5950 4 St W

**LETHBRIDGE & DISTRICT EXHIBITION**  
Administration Office  
3401 6 Av S-----Lethbridge 328-4491  
Fax Line-----Lethbridge 320-8139  
Soccer Bldg-----Lethbridge 328-5994

**Taber Exhibition Building**  
6602 53 St-----Taber 223-9539

Don't forget to plan for concealed telephone conduit and convenient locations for telephone outlets when you build your new home. These built-in telephone facilities add real value to a home yet their cost is very small if they are installed during construction.



# Big Horn Pest Control Ltd.

Locally Owned & Operated In  
Lethbridge & Area

- CONTROLLING THE ENTIRE INSECT & RODENT SPECTRUM
- TREE SPRAYING & WEED CONTROL
- GRAIN FUMIGATING
- SERVICE WITH DISCRETION

Call Allan Schaaf, M.Sc.  
(Professional Entomologist)

1212 - 6th AVE. S., LETHBRIDGE T1J 1A4  
RESIDENCE 328-8426

## 320-1555

## The best GAS SAVER in town!



Drive your phone instead of your car. Save a trip.

## If They Come Back...So Do We.

**MONEY BACK GUARANTEE**

PCO guarantees to eliminate your specific pest infestation. Whether you are faced with insects of any kind, rodents or any other pest infestation, we guarantee to remove it safely and effectively. If we have not eliminated your infestation within 90 days, we will refund your money completely.

ONLY FROM

**Johnson** An **SCS** Company  
**PCO** PEST CONTROL

LETHBRIDGE  
381-9100  
P C O SERVICES INC

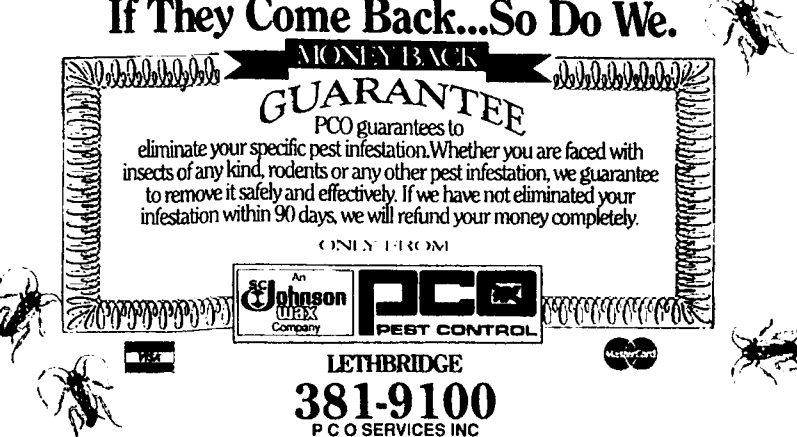

PIGEONS & SPARROWS 	 SQUIRRELS, SKUNKS, GOPHERS	COMMON BAT 	MICE & RATS 
---	---	---	--

Get fast, safe, effective Pest Control by

# Poulin's exterminators

- We sell pesticides, do-it-yourself kits & trap rentals
- Mosquitos and Fly Control Products
- Fumigation of structural & commodity items
- Offensive odor removal • Weed Control
- Tree Spraying • Ground Sterilization
- Sonic Devices

Free Estimates • Written Guarantee

LETHBRIDGE  
**328-2491**  
FAX 569-2560

CALGARY 272-6006    MEDICINE HAT 529-9237

24 HOUR ANSWERING SERVICE

Member: Alberta Pesticide Applicators' Association

SOW BUGS 	
SILVER FISH 	FLEAS 
BEEES & WASPS 	ANTS 
FLYS 	CONFUSED FLOUR BEETLES 
ODOR CONTROL 	BED BUGS 

**Facsimile Communication Equipment & Supplies**

A K S Electronic Services ---Coakdale 345-5393

**COOLIDGE OFFICE EQUIPMENT LTD**

PANAFAX • SHARP  
SALES & SERVICE

316 7 St S -----Lethbridge 320-1718

**Cypress Business Equipment Ltd**

2830 12 Av N -----Lethbridge 328-8604

(See Our Display Advertisement)

**Looker Office Equipment (1972) Ltd**

1221 2 Av S -----Lethbridge 327-8591

(See Our Display Advertisement)

**Marshall R Business Equipment Ltd**

-----Lethbridge 381-0966

**Minolta Office Systems Ltd**

1802 2 Av S -----Lethbridge 328-1188

(See Our Display Advertisement)

**Facsimile Communication Equipment Supplies (Cont'd)**

**PITNEY BOWES**

(No Charge Dial) -----1-800-352-8250

Diagnostic Service

Fax Line (No Charge Dial) -----1-800-668-9194

**S O S-COMPUTER WORLD**

FAX MACHINES • WORD PROCESSORS

COMPUTERS • PRINTERS • LAPTOPS

Complete Accessories

5335 48 Av -----Taber 223-4240

**Tri-Tech Office Products Ltd**

1430d 31 St N -----Lethbridge 328-8077

(See Our Display Advertisement)

(CONTINUED NEXT LISTING PAGE)

Let Your Fingers Do The Walking

**XEROX**

**Something no other Fax can deliver.**

XEROX TOTAL SATISFACTION GUARANTEE

Xerox Canada Ltd. 1502 - 3rd Ave. S., Lethbridge

Sales

Service

Supplies

(No Charge)

(No Charge)

328-7116

1-800-387-4311

1-800-668-0199

**XEROX**

The Document Company

XEROX and The Document Company are trademarks of XEROX CORPORATION, used by XEROX CANADA LTD. as a registered user.

**Extermination & Fumigation- Pest Control (Cont'd)**

**P C O SERVICES INC**

-----Lethbridge 381-9100

(See Our Display Advertisement)

Poulin's Exterminators -----Lethbridge 328-2491

(See Our Display Advertisement)

**Fabric Shops**

Alberta Fabrics Wholesale---Edmonton 484-6789

**ARLENE'S FABRIC & DRAPERY**

Complete Line Of Fabrics From  
In-Store Drapery To All Fashion Fabrics  
Notions • Lace • Accessories

5316 48 Av -----Taber 223-1669

**DISCOUNT FABRICS**

215 Stafford Dr S -----Lethbridge 328-1349

**Fabric Shops (Cont'd)**

**ECONOMY REMNANT CENTRE**

608 3 Av S -----Lethbridge 328-0252

**FABRIC BOUTIQUE**

2119 20 St -----Nanton 646-2086

**FABRICLAND**

FABRICS, PATTERNS  
& NOTIONS  
DRAPERIES & UPHOLSTERY

DRAPERY & UPHOLSTERY CENTRE  
317 - 4 St. S.

323 4 St S -----Lethbridge 328-5119

**Fanny's Fabrics**

1245 2 Av S -----Lethbridge 329-3355

(See Our Display Advertisement)

**IMAGINATION UNLIMITED**

FABRIC, ART & CRAFT SUPPLIES  
BERNINA & OMEGA DEALER

257 Main St -----Cardston 653-2633

**International Fabric Liquidators**

110 13 St S -----Lethbridge 329-8090

Fax Line -----Lethbridge 329-8094

Lacey's Fabrics 5328 48 Av -----Taber 223-3707

Stitch In Time

207 Main St NW -----Milk River 647-3931

**SUZAN'S FABRICS LTD**

Bridal & Special Occasion Fabrics  
Quality Wools, Silks & Cottons  
Custom Sewing & Alteration Service

320 6 St S -----Lethbridge 320-9595

**THREAD BEAR LTD**

FABRICS & NOTIONS  
QUILTING SUPPLIES & CLASSES  
GIFTS & CARDS

3 1021 2 Av N -----Lethbridge 329-1551

Look before you leaf. Try the index at the front of the directory.

Plain paper fax is now  
plainly affordable



Canon  
LASER CLASS  
FAX-L708



CYPRESS

**328-8604**

FAX 320-0716

2830 - 12th AVE. N., LETHBRIDGE T1H 5J9

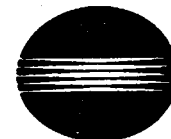

**MINOLTA  
OFFICE SYSTEMS  
COPIERS/FAX  
PAPER SHREDDERS  
328-1188**

FAX 328-4777

1802 - 2nd AVE. S.

LETHBRIDGE T1J 0G4

**LOOKER  
OFFICE EQUIPMENT  
(1972) LTD.**

AUTHORIZED  
DEALER FOR

SAVIN & RICOH  
FACSIMILE EQUIPMENT

• FAX SERVICE  
• RENTALS

FAX # 328-0202

**327~8591**

1221 - 2nd AVE. S., LETHBRIDGE

**TRI-TECH  
OFFICE PRODUCTS  
Ltd.**

SUPPLIES FOR MOST  
MAKES OF FACSIMILE  
EQUIPMENT.

AUTHORIZED SHARP  
FACSIMILE DEALER

RECONDITIONED & RENTAL  
MACHINES AVAILABLE

FAX 329-0977

**328-8077**

1430d - 31st St. N., Lethbridge

**FANNY'S  
FABRICS**

our name is your guarantee

An enormous selection of fabrics, notions,  
patterns, foam, home dec. and craft  
supplies! Come in and see for yourself!

Fanny's has it all!

1245 - 2nd Ave. S.  
**329-3355**

Lethbridge

**Facsimile Communication Equipment & Supplies (Cont'd)**

**XEROX CANADA LTD**  
1502 3 Av S .....Lethbridge 328-7116  
(See Our Display Advertisement)

**XEROX FACSIMILE EQUIPMENT**

Something no other  
Fax can duplicate. **XEROX**<sup>®</sup>  
XEROX TOTAL SATISFACTION  
GUARANTEE  
Only you decide when  
you're satisfied.

**AUTHORIZED SALES AGENTS**

Copy Magic  
Serving Claresholm  
12825 20 Av  
Blairmore .....Crownsnest Pass 562-2277  
MicroAge Computer Centres  
1502 3 Av S .....Lethbridge 328-0555

**Facsimile Communication Service**

Copy Express 811 3 Av S .....Lethbridge 329-9055  
Network Business Services Ltd  
515 7 St S .....Lethbridge 327-3777  
Fax .....Lethbridge 329-0089  
Printers Inc 1011 3 Av S .....Lethbridge 328-9111  
S & G Printers  
406 Stafford Dr S .....Lethbridge 320-7655  
**T N S BUSINESS CENTRE LTD**  
1222 3 Av S .....Lethbridge 329-9090  
Fax Line .....Lethbridge 329-4139

**Family Planning**

**NATURAL FAMILY PLANNING  
(ALBERTA) BILLINGS CENTRE**  
829 17 St S .....Lethbridge 327-3102

**Fans-Electric**

**BENNETTS R S LTD**  
TWIN CITY FAN  
A.B.B. FLAKT  
Box 5245 Stn A .....Calgary 271-2552  
Fax Line .....Calgary 278-2467

Carefree Kitchens  
239 13 St N .....Lethbridge 329-8222  
(See Our Display Advertisement)

**DESIGN LIGHTING STUDIO (1989) LTD**  
CEILING FANS & LIGHT KITS  
See Our Ad Under Lighting Fixtures  
100 905 1 Av S .....Lethbridge 328-9524

**YELLOW PAGES get action!**  
You can carry your firm's name  
and advertising into the homes  
and business places of your  
best prospects by being repre-  
sented in the YELLOW PAGES.

**Farm Lands & Management**

Blood Tribe Irrigation Management  
Box 90 .....Standoff 737-3900

**Farm Machinery-Repairing**

**ABLE TRUCK & TRAILER REPAIRS**  
CLUTCHES • HYDRAULIC EQUIPMENT  
TUNE-UPS & ENGINE REPAIRS  
(NO CHARGE DIAL) 1-800-267-2999  
2345 2A Av N .....Lethbridge 327-2626

Brouwer Automotive  
Box 297 .....Picture Butte 732-4608

**KALSAN MECHANICAL REPAIR**  
FARM MACHINERY REPAIRS  
HEAVY DUTY MECHANIC  
CELLULAR 652-9642  
4225 3 St E .....Claresholm 625-4818

Vanee Farm Centre Inc  
3605 5 Av N .....Lethbridge 327-1100  
Vare Ken 354 1 Av W .....Cardston 653-1450

**Farm Machinery & Supplies**

Agri-Distributing Ltd .....Lethbridge 329-1778  
Or Call Calgary Res .....Calgary 256-1909  
Australian Canadian Agricultural Machinery  
Corp 1302 18 Av .....Coaldale 345-5717  
Shop 1306 15 Av .....Coaldale 345-2982  
Big Iron Farm Equipment Ltd  
6020 62 St .....Taber 223-1818  
Bishop Service Ltd  
5202 1 St .....Claresholm 625-3010  
Butte Motors & Farm Supply Ltd  
320 Highway Av N .....Picture Butte 732-4406  
Calhoun Sales & Service Ltd  
205 Main St .....Foremost 867-3622

IS EACH LINE OF YOUR  
BUSINESS UNDER  
THE APPROPRIATE  
"YELLOW PAGES" HEADING?

**Farm Machinery & Supplies (Cont'd)**

**CENTURY SALES & SERVICE LTD**

Mitutoyo  
Precision Tools  
Proto - Ridgid  
Black & Decker  
Taps & Dies - H.S. Drills  
Hack Saw Blades & Frames  
Nuts & Bolts  
"FOR SERVICE CALL"



**CENTURY SALES & SERVICE LTD**  
3004 9 Av N .....Lethbridge 329-4747

**CHALLENGER FORD NEW HOLLAND  
LTD** Box 850 .....Claresholm 625-3321

**CHARLTON & GILBERTSON FARM  
EQUIPMENT LTD**  
AGRICULTURAL EQUIPMENT, BELTS, BEARINGS  
SEALS & CHAIN HYDRAULIC SERVICE  
6208 54 Av .....Taber 223-2522

Coaldale Iron Products Ltd  
1209 18 Av .....Coaldale 345-3973  
(See Our Display Advertisement)

Dietrich's Equipment Ltd  
Logan Double L & Harriston Potato Equip  
2636 2 Av N .....Lethbridge 320-8964  
Edwards Grain Guard  
3102 5 Av N .....Lethbridge 320-5585  
Enchant Farm Equipment  
Ltd .....Enchant 739-3757

**ESKIMO REFRIGERATION LTD**

A/C UNITS, PARTS, TOOLS, OILS & FREON

- AUTOMOTIVE
- AGRICULTURAL
- H.D. TRUCKS
- INDUSTRIAL



"FOR INFORMATION CALL"

Eskimo Refrigeration Ltd  
3656 61 Av SE .....Calgary 279-8091

**Farm Machinery & Supplies (Cont'd)**

Evcon Farm Equipment Ltd  
610 30 St N .....Lethbridge 329-6011  
(See Our Display Advertisement)

**FARM MILLS & STORAGE**

Grain Augers & Automatic Grain Rollers  
Elevator Legs • Replacement Flighting

Rave Industrial Park .....Lethbridge 320-9497

Fisher Diesel Injection Services Ltd  
2903 7 Av N .....Lethbridge 327-0711

**FORD NEW HOLLAND FARM  
EQUIPMENT-**

SALES-PARTS-SERVICE  
**PINCHER CREEK FARM CENTRE INC**  
1088 Macleod St .....Pincher Creek 627-3646  
Fax .....Pincher Creek 627-2785

**TRIPLE "O" SALES LTD**  
Hwy 4 & 4 Av NE .....Milk River 647-3737

**GEN MANUFACTURING LIMITED**  
HIGH CHROMIUM/CARBON WEARPOINTS  
Seeder Ground Tools & Banding Equipment  
24 HOUR SERVICE  
2002 20 St .....Coaldale 345-3414

Green Power Ltd 5802 56 Av .....Taber 223-3588

Growers Supply Limited  
401 1 St N .....Vauxhall 654-2223  
If Busy Call .....Vauxhall 654-2533  
(See Our Display Advertisement)

Hanlon Ag Centre Ltd  
3005 18 Av N .....Lethbridge 329-8686  
(See Our Display Advertisement)

Hi-Way Service Inc  
215 32 St S .....Lethbridge 327-3154  
Grain Division .....Lethbridge 320-6866  
(See Our Display Advertisement)

Horizon Implements Ltd  
Hwy 36 N .....Taber 223-8928  
(See Our Display Advertisement)

K & D Implements Ltd  
5 Hwy W .....Cardston 653-3566

(CONTINUED NEXT LISTING PAGE)

**EVCON FARM EQUIPMENT LTD.**

AUTHORIZED DEALER: SHORT LINES, GEHL

**WESTWARD PARTS - SPECIALISTS OF FULL LINE IMPLEMENT & TRACTOR PARTS**

**SALES - PARTS - SERVICE - RENTALS**

610 - 30th ST. N., LETHBRIDGE

AFTER HRS: EVERETT TREMPNER - RES. 381-6011

MOBILE: 380-0199

DARREN TREMPNER MOBILE: 380-0083

**329-6011**

FAX: 328-8787



**Carefree Kitchens**

Designer Ceiling Fans  
&  
Light Fixtures

HOUSEHOLD COMMERCIAL

"FREE SHOP AT HOME SERVICE"

**329-8222**

FAX LINE 320-8568

239 - 13th ST. N., LETHBRIDGE

**COALDALE IRON  
PRODUCTS LTD.**

MANUFACTURER OF:

- GROUND PROPELLED HEXAGON ROD WEEDER ATTACHMENTS
- CUSTOM MADE HYDRAULIC HOSES & REPAIRS
- IRRIGATION WHEEL
- MOVE BRACES
- SUPERSLIDE TRUCK FLOOR LINERS



WALTER ISAAK RES: 345-4817

**345-3973**

1209 - 18th AVE., COALDALE

**Growers Supply Limited**

Lilliston Cultivators — Chemicals  
Welding Supplies — Hardware  
Tools — Farm Machinery  
& Parts  
Specializing in  
Lockwood Potato Equipment

"Everything That The Farmer Needs"

**654-2223**

481 1st ST. N.

OR CALL 654-2533

VAUXHALL, ALTA.  
T0K 2K0